



# Cue Energy Resources Limited

A.B.N. 45 066 383 971

25th Floor  
500 Collins Street  
Melbourne Victoria 3000  
Australia

Telephone: (03) 9629 7577  
Facsimile: (03) 9629 7318

Email: [mail@cuenrg.com.au](mailto:mail@cuenrg.com.au)  
Website: [www.cuenrg.com.au](http://www.cuenrg.com.au)

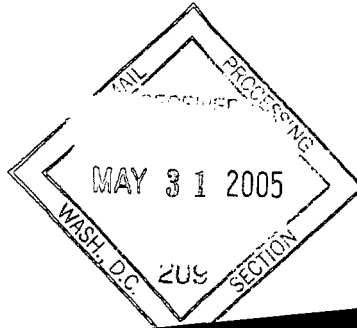

19 May 2005



Securities & Exchange Commission  
Judiciary Plaza,  
450 Fifth Street  
Washington DC 20549

**SUPPL**

Dear Sir/Madam,

Please see attached information furnished pursuant to Section 12g3-2(b).  
Our file number is 82-34692.

Yours faithfully,

Andrew M Knox  
Public Officer

Enc.

PROCESSED

JUN 09 2005

J THOMPSON  
FINANCIAL

Rule 2.7, 3.10.3, 3.10.4, 3.10.5

# Appendix 3B

## New issue announcement, application for quotation of additional securities and agreement

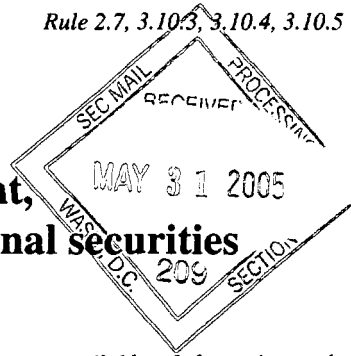

*Information or documents not available now must be given to ASX as soon as available. Information and documents given to ASX become ASX's property and may be made public.*

Introduced 1/7/96. Origin: Appendix 5. Amended 1/7/98, 1/9/99, 1/7/2000, 30/9/2001, 11/3/2002, 1/1/2003.

Name of entity

Cue Energy Resources Limited

ABN

45 066 383 971

We (the entity) give ASX the following information.

### Part 1 - All issues

*You must complete the relevant sections (attach sheets if there is not enough space).*

- |   |  |  |
|---|--|--|
| 1 | +Class of +securities issued or to be issued   | Ordinary Fully Paid Shares                           |
| 2 | Number of +securities issued or to be issued (if known) or maximum number which may be issued  | 87,088,751 New Ordinary fully Paid Shares            |
| 3 | Principal terms of the +securities (eg, if options, exercise price and expiry date; if partly paid +securities, the amount outstanding and due dates for payment; if +convertible securities, the conversion price and dates for conversion) | 87,088,751 Ordinary Fully Paid Shares @ AUD 20 cents |

**Appendix 3B**  
**New issue announcement**

4 Do the +securities rank equally in all respects from the date of allotment with an existing +class of quoted +securities?

If the additional securities do not rank equally, please state:

- the date from which they do
- the extent to which they participate for the next dividend, (in the case of a trust, distribution) or interest payment
- the extent to which they do not rank equally, other than in relation to the next dividend, distribution or interest payment

Yes (Ordinary Shares)

5 Issue price or consideration

Ordinary Shares AUD 20 cents

6 Purpose of the issue  
 (If issued as consideration for the acquisition of assets, clearly identify those assets)

To replace funds expended on buying back into and, to assist in, appraising the Jeruk field in the Sampang PSC, Indonesia.

7 Dates of entering +securities into uncertificated holdings or despatch of certificates

4 July 2007

8 Number and +class of all +securities quoted on ASX (including the securities in clause 2 if applicable)

Number	+Class
522,532,506	Ordinary Fully Paid Shares

+ See chapter 19 for defined terms.

9	Number and *class of all *securities not quoted on ASX (including the securities in clause 2 if applicable)	Number	*Class	
			Exercise Price (cents A\$)	Expiry Date
		500,000	12 cents	02/05/06
		500,000	15 cents	02/05/06
		1,000,000	30 cents	02/05/07
		1,000,000	35 cents	02/05/07
10	Dividend policy (in the case of a trust, distribution policy) on the increased capital (interests)			

## Part 2 - Bonus issue or pro rata issue

11	Is security holder approval required?	No
12	Is the issue renounceable or non-renounceable?	Renounceable
13	Ratio in which the *securities will be offered	One new share for every five existing shares
14	*Class of *securities to which the offer relates	Ordinary shares
15	*Record date to determine entitlements	30 May 2005
16	Will holdings on different registers (or subregisters) be aggregated for calculating entitlements?	Yes
17	Policy for deciding entitlements in relation to fractions	Rounded down

+ See chapter 19 for defined terms.

**Appendix 3B**  
**New issue announcement**

---

18 Names of countries in which the entity has \*security holders who will not be sent new issue documents

Note: Security holders must be told how their entitlements are to be dealt with.

Cross reference: rule 7.7.

United States of America,  
United Kingdom,  
Hong Kong,  
Malaysia,  
Canada,  
Indonesia,  
Switzerland,  
Oman,  
Phillipines,  
China,  
Denmark,  
Fiji,  
Ghana,  
Japan,  
Kiribati,  
Norway,  
Thailand,  
Taiwan Province of China

19 Closing date for receipt of acceptances or renunciations

27 June 2005

20	Names of any underwriters	Todd Petroleum Mining Company Ltd (80%) Geat Missenden Holdings Ltd (20%)
21	Amount of any underwriting fee or commission	5%
22	Names of any brokers to the issue	None
23	Fee or commission payable to the broker to the issue	None
24	Amount of any handling fee payable to brokers who lodge acceptances or renunciations on behalf of *security holders	None
25	If the issue is contingent on *security holders' approval, the date of the meeting	N/A
26	Date entitlement and acceptance form and prospectus or Product Disclosure Statement will be sent to persons entitled	1 June 2005 (estimate)
27	If the entity has issued options, and the terms entitle option holders to participate on exercise, the date on which notices will be sent to option holders	N/A
28	Date rights trading will begin (if applicable)	24 May 2005
29	Date rights trading will end (if applicable)	20 June 2005
30	How do *security holders sell their entitlements <i>in full</i> through a broker?	On market
31	How do *security holders sell <i>part</i> of their entitlements through a broker and accept for the balance?	On market

**Appendix 3B**  
**New issue announcement**

---

- 32 How do \*security holders dispose of their entitlements (except by sale through a broker)?
- 33 \*Despatch date

**Part 3 - Quotation of securities**

*You need only complete this section if you are applying for quotation of securities*

- 34 Type of securities  
(tick one)
- (a)  Securities described in Part 1
- (b)  All other securities  
Example: restricted securities at the end of the escrowed period, partly paid securities that become fully paid, employee incentive share securities when restriction ends, securities issued on expiry or conversion of convertible securities

**Entities that have ticked box 34(a)**

**Additional securities forming a new class of securities**

*Tick to indicate you are providing the information or documents*

- 35  If the \*securities are \*equity securities, the names of the 20 largest holders of the additional \*securities, and the number and percentage of additional \*securities held by those holders
- 36  If the \*securities are \*equity securities, a distribution schedule of the additional \*securities setting out the number of holders in the categories  
1 - 1,000  
1,001 - 5,000  
5,001 - 10,000  
10,001 - 100,000  
100,001 and over
- 37  A copy of any trust deed for the additional \*securities

**Entities that have ticked box 34(b)**

38 Number of securities for which  
+quotation is sought

39 Class of +securities for which  
quotation is sought

40 Do the +securities rank equally in all  
respects from the date of allotment  
with an existing +class of quoted  
+securities?

If the additional securities do not  
rank equally, please state:

- the date from which they do
- the extent to which they  
participate for the next dividend,  
(in the case of a trust,  
distribution) or interest payment
- the extent to which they do not  
rank equally, other than in  
relation to the next dividend,  
distribution or interest payment

41 Reason for request for quotation  
now

Example: In the case of restricted securities, end of  
restriction period

(if issued upon conversion of  
another security, clearly identify that  
other security)

	Number	+Class
42 Number and +class of all +securities quoted on ASX (including the securities in clause 38)		



### Quotation agreement

1 +Quotation of our additional +securities is in ASX's absolute discretion. ASX may quote the +securities on any conditions it decides.

2 We warrant the following to ASX.

- The issue of the +securities to be quoted complies with the law and is not for an illegal purpose.
- There is no reason why those +securities should not be granted +quotation.
- An offer of the +securities for sale within 12 months after their issue will not require disclosure under section 707(3) or section 1012C(6) of the Corporations Act.

Note: An entity may need to obtain appropriate warranties from subscribers for the securities in order to be able to give this warranty

- Section 724 or section 1016E of the Corporations Act does not apply to any applications received by us in relation to any +securities to be quoted and that no-one has any right to return any +securities to be quoted under sections 737, 738 or 1016F of the Corporations Act at the time that we request that the +securities be quoted.
- We warrant that if confirmation is required under section 1017F of the Corporations Act in relation to the +securities to be quoted, it has been provided at the time that we request that the +securities be quoted.
- If we are a trust, we warrant that no person has the right to return the +securities to be quoted under section 1019B of the Corporations Act at the time that we request that the +securities be quoted.

- 3 We will indemnify ASX to the fullest extent permitted by law in respect of any claim, action or expense arising from or connected with any breach of the warranties in this agreement.
- 4 We give ASX the information and documents required by this form. If any information or document not available now, will give it to ASX before +quotation of the +securities begins. We acknowledge that ASX is relying on the information and documents. We warrant that they are (will be) true and complete.



Sign here: ..... Date: 19 May 2005  
(Public Officer)

Print name: AM Knox  
=====

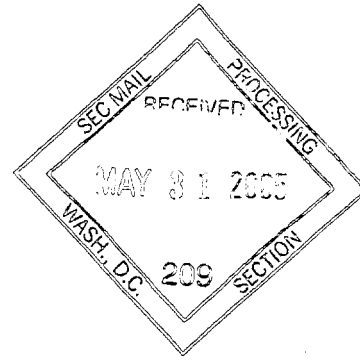

ABN 45 066 383 971

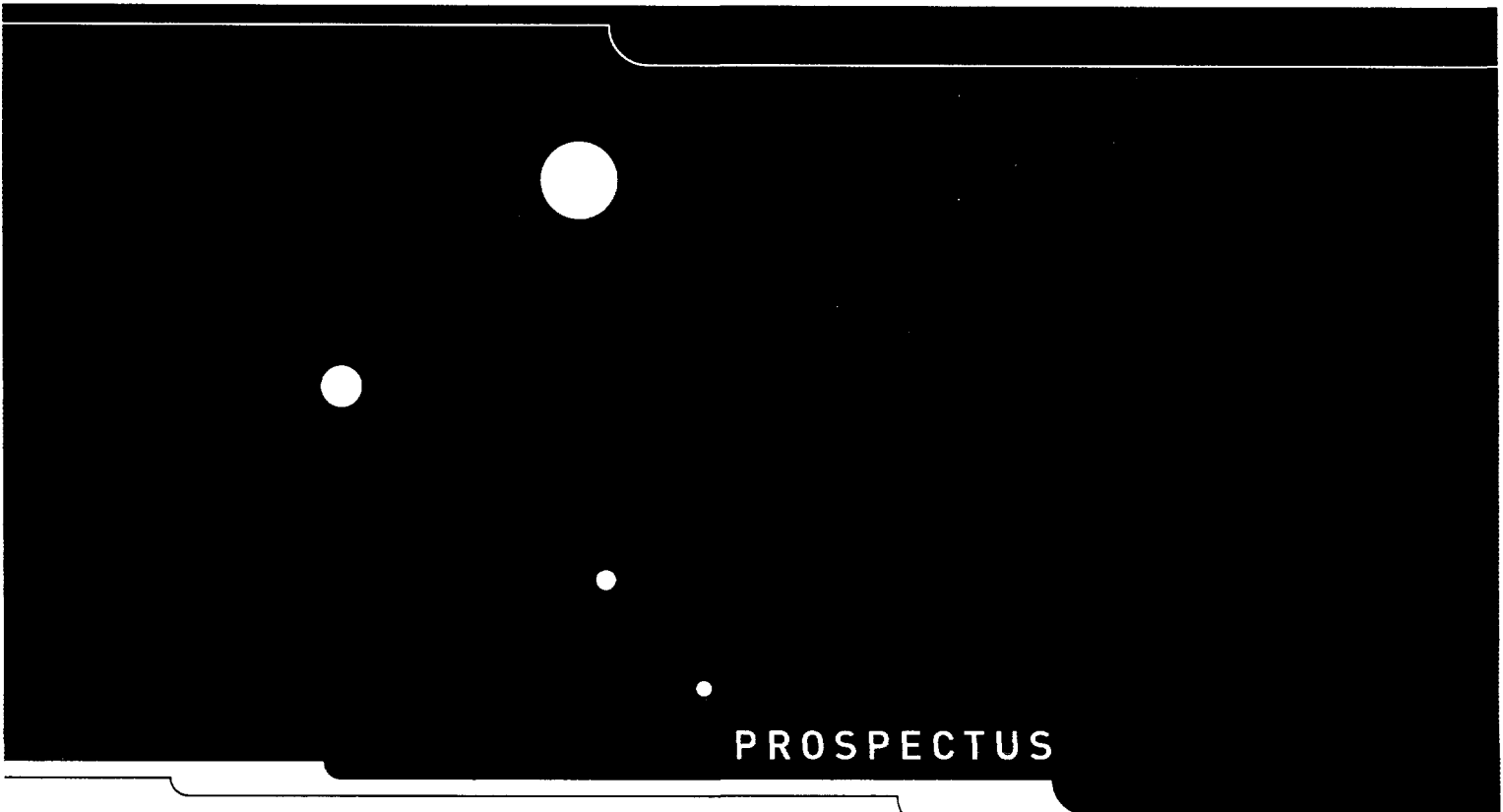

# PROSPECTUS

## CONFIDENTIAL

FOR A RENOUNCEABLE PRO-RATA ENTITLEMENT OFFER OF ONE NEW SHARE FOR EVERY FIVE EXISTING SHARES AT AN ISSUE PRICE OF AUD20 CENTS.

### This Prospectus is important

Shareholders should be aware that their entitlements may have value and should deal with them rather than allow them to lapse. If you are in any doubt about how to deal with your entitlement, please contact your stock broker, financial adviser, solicitor, accountant or other professional adviser immediately.

The Issue is Fully Underwritten.

The securities offered under this Prospectus are of a speculative nature.

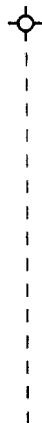

# CORPORATE DIRECTORY

## DIRECTORS

R.G. Tweedie LL.B - Chairman  
E.G. Albers LL.B  
K. Hoolihan MSc(Hons)  
L. Musca LL.B

## REGISTERED OFFICE

### AUSTRALIA

25th Floor, 500 Collins Street  
Melbourne Victoria 3000  
Telephone: 61 3 9629 7577  
Facsimile: 61 3 9629 7318  
E-mail: mail@cuenrg.com.au

## STOCK EXCHANGE LISTINGS

### Australia

Australian Stock Exchange (ASX)  
Level 3, 530 Collins Street  
Melbourne Victoria 3000 Australia  
ASX Code: CUE  
Telephone: 61 3 9617 8611

### Papua New Guinea

Port Moresby Stock Exchange (POMSoX)  
Level 4, Defens Haus  
Cnr of Champion Parade and Hunter Street  
PO Box 1531, Port Moresby, NCD  
Papua New Guinea  
POMSoX Code: CUE  
Telephone: 675 320 1980  
Facsimile: 675 320 1981

## AUDITOR

PKF  
Level 11, CGU Tower, 485 La Trobe Street  
Melbourne Victoria 3000 Australia

## SHARE REGISTRY

### Australia

Computershare Investor Services Pty Limited  
Yarra Falls  
452 Johnston Street  
Abbotsford VIC 3067 Australia  
General enquiries: 1300 850 505  
Overseas holders: +61 3 9415 4000  
Facsimile: 61 3 9473 2500  
Website: www.computershare.com  
Email: web.queries@computershare.com.au

## Papua New Guinea

Deloitte Touche Tohmatsu  
Level 12, Deloitte Tower  
Douglas Street  
PO Box 1275  
Port Moresby, NCD  
Papua New Guinea  
Telephone: 675 321 1888  
Facsimile: 675 321 1986

## IMPORTANT DATES

EVENT	PROPOSED DATE <i>(Estimate only)</i>
Rights Trading Opens and Shares Trade ("ex Rights")	24 May 2005
Record Date	30 May 2005
Offer Opens	6 June 2005
Stock Exchange Rights Trading Ceases	20 June 2005
Offer Closes	27 June 2005
Allotment of Shares	30 June 2005
Expected date of issue of Shareholder Statements	4 July 2005

## FORWARD LOOKING STATEMENTS

Various statements in this Prospectus constitute statements relating to intentions, future acts and events. Such statements are generally classified as forward looking statements and involve known and unknown risk, uncertainties and other important factors that could cause those future acts, events and circumstances to differ from the way or manner in which they are expressly or impliedly portrayed herein.

**No securities will be issued or allotted on the basis of this prospectus later than 13 months after the date of this prospectus.**

This Prospectus is dated 19 May 2005. A copy of this Prospectus has been lodged with the Australian Securities and Investments Commission on 19 May 2005. The Australian Securities and Investments Commission take no responsibility for the contents of this Prospectus.

## CONTENTS

2	CHAIRMAN'S LETTER
4	SUMMARY OF OFFER
8	IMPORTANT DATES
14	MAIN TERMS OF THE OFFER
28	CAPITAL STRUCTURE AND EFFECT OF THE ISSUE ON THE COMPANY
30	GLOSSARY

## IMPORTANT NOTICE

This Prospectus is dated 19 May 2005 and contains an offer to Eligible Shareholders in Cue Energy Resources Limited ("Cue Energy Resources") to subscribe for New Shares in Cue Energy Resources.

A copy of this Prospectus was lodged with the Australian Securities and Investment Commission ("ASIC") on 19 May 2005

ASIC, the Australian Stock Exchange Limited ("ASX") and Port Moresby Stock Exchange Limited ("POMSIX") take no responsibility for the contents of this Prospectus.

If you are in any doubt as to how to deal with this Prospectus, please consult a member of ASX or POMSIX or your financial or legal adviser immediately.

Receipt of this Prospectus and/or Letter of Entitlement and Acceptance Form will not constitute an offer of, or an invitation to subscribe for, any of the New Shares in those jurisdictions in which it would be unlawful to make such an offer or invitation. Cue Energy Resources prohibits the sending of this Prospectus and Letter of Entitlement and Acceptance Form into any such jurisdictions and reserves the right to refuse to issue any New Shares if it believes to do so would violate the applicable legal or regulatory requirements.

In this Prospectus:

1. Definitions of capitalised terms used are contained in the glossary on page 30.
2. A reference to time, unless the contrary is stated, is a reference to Australian Eastern Standard Time.

## LETTER TO SHAREHOLDERS



May 2005

Dear Shareholder,

### **Cue Energy Resources Limited Entitlement Offer**

As you are aware, Cue Energy Resources Limited ("Cue") has reinstated its rights in the Jeruk oil discovery in the Sampang Production Sharing Contract (PSC) area, offshore East Java, Indonesia. By doing so, Cue has regained its full 15% interest in what could be a significant oil discovery. Cue is now required to pay a lump sum of approximately AUD\$11 million which is equivalent to the costs it would have incurred in the Jeruk -1 and Jeruk -2 wells and, in addition, will be required to pay a premium based on these costs, but only out of future Jeruk production (see also page 19).

In May 2005, it is proposed to re-enter the Jeruk -2 well, and to sidetrack, core and test the well. The rights issue will fund this activity and the lump sum payment. An additional four appraisal wells are proposed to be drilled beginning in the fourth quarter 2005. Cue will be required to also fund its 15% share of this activity. A further equity raising will be required to fund this drilling programme.

Cue has other ongoing activities. It is also participating in a joint venture development of the Oyong oil and gas field in the Sampang PSC area, offshore East Java, Indonesia. Exploration drilling is expected to continue in the PSC in an effort to find additional hydrocarbon discoveries that may compliment the Oyong development.

Significant progress has been achieved by the operator, Santos, towards the development of Oyong. The well head platform has been installed and development drilling is beginning, with oil production expected to begin by year end 2005, and gas production beginning around year end 2006.

In Papua New Guinea, oil production continues from the SE Gobe field, in which Cue Energy Resources has a participating interest, at a total field rate of approximately 6500 barrels of oil per day (Cue share approximately 250 barrels of oil per day). The recent SE Gobe 11 development well is projected to add around 2000 barrels of oil per day to the field rate. A study has also been made in an effort to commercialise some of Cue Energy Resources' share of discovered gas resources.

In March 2005, Cue completed the purchase of a 5% interest in the Maari oil field, in the offshore Taranaki Basin of New Zealand. The purchase price was AUD\$6.2 million. We expect that a Maari development decision will be made later in 2005, with first oil production expected in mid 2007.

Following shareholder mandate at the last General Meeting, in December 2004 and February 2005, Cue made placements of a total of 100 million shares to raise a total of AUD\$28 million (before fees) for Oyong oil development costs and for Maari purchase and development costs. These placements did not raise funds specifically for Jeruk.

While Cue can use existing cash funds to pay the Jeruk lump sum and Jeruk -2 re-entry appraisal costs in the short term, these funds will need to be replaced to cover Oyong and Maari costs for which those funds had been allocated.

At the annual General Meeting of shareholders of Cue Energy Resources on 26 November 2004, shareholders also indicated to the board of directors ("the Board") that they would like to have the opportunity to take up further shares by way of entitlement issues, should Cue Energy Resources require further capital.

The Board therefore has resolved to offer Cue Energy Resources' shareholders a one for five renounceable pro rata entitlement offer of new Ordinary Shares at AUD20 cents ("New Share"). This means that for every five Ordinary Shares you hold you will have the right to subscribe for one New Share or to sell your Rights to take up that New Share.

The Offer will raise approximately AUD\$17.4 million from the issue of New Shares. The offer is fully underwritten by Todd Petroleum Mining Company Limited (a company associated with me and another Cue director Mr. K. Hoolihan) and Great Missenden Holdings Pty Ltd. (a company associated with Cue director, Mr E.G. Albers).

I encourage you to take up your entitlement to support the Company's projects.

Yours sincerely



**Richard Tweedie**  
*Chairman*

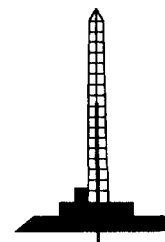
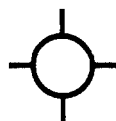

## SUMMARY OF THE OFFER

### THE ISSUER

Cue Energy Resources is the issuer of the Rights and New Shares offered under this Prospectus. Cue Energy Resources is a company registered under the Corporations Act 2001 having its registered office at Level 25, 500 Collins Street, Melbourne, Australia.

### THE OFFER

This Prospectus offers all Eligible Shareholders who are on the register of Cue Energy Resources as at 5.00 pm on the Record Date (30 May 2005), the opportunity to subscribe for one Cue Energy Resources Ordinary Share ("New Share") for every five Existing Shares currently held.

### SUBSCRIPTION PRICE AND ENTITLEMENT

The subscription price for the New Shares is AUD20 cents each, to be paid in Australian currency. Each Eligible Shareholder's entitlement (also referred to as Rights) is recorded on the Letter of Entitlement and Acceptance Form accompanying this Prospectus. Fractional entitlements to New Shares will be disregarded.

### PURPOSE

The issue of New Shares will raise approximately AUD\$17.4 million in new capital for Cue Energy Resources, which will enable it to replace funds expended on buying back into and, to assist in, appraising the Jeruk field.

### UNDERWRITING

The Offer is fully underwritten by Todd Petroleum Mining Company Limited as to 80% and Great Missenden Holdings Pty Ltd as to 20%.

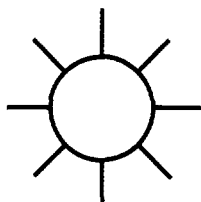
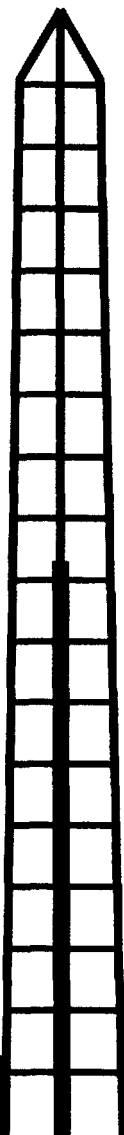



## QUOTATION

Applications will be made by Cue Energy Resources for the Rights and New Shares to be quoted on the ASX and POMSOX within 7 days after the date of this Prospectus. ASX and POMSOX accept no responsibility for any statement in this Prospectus.

## ACTION TO BE TAKEN BY SHAREHOLDERS

You may take one of the following actions:

- A) accept** your entitlement in full; or
- B) sell part** of your entitlement (Rights) and accept the balance; or
- C) sell** your entitlement (Rights) in full; or
- D) do nothing** and forfeit your entitlement.

### Important Notice

If you take no action by 5.00pm on 27 June 2005 your entitlement to subscribe for New Shares will be forfeited, you will not receive any potential value residing in your Rights and your shareholding may be diluted. Similarly, if you accept less than your full entitlement and you do not sell the balance of your Rights to subscribe for New Shares, you will not receive any value residing in the entitlement not accepted or sold and your shareholding may be diluted. Therefore it is important that you take action either to accept your entitlement or sell your Rights. Set out below are instructions on how to take each of the alternate actions set out above.

#### A. Acceptance in full

To accept your entitlement in full:

- (a) complete the enclosed Entitlement and Acceptance Form in accordance with the instructions on that form;
- (b) attach your cheque or bank draft (denominated in Australian dollars) made payable to "Cue Energy Resources Limited" for the amount required to be paid in accordance with the payment instructions set out below; and

- (c) forward your completed Entitlement and Acceptance Form and your cheque or bank draft to:

#### Postal:

Cue Energy Resources Limited  
c/- Computershare Investor Services Pty Limited  
GPO Box 52  
Melbourne Vic 8060 Australia

#### Hand Delivery:

Cue Energy Resources Limited  
c/- Computershare Investor Services Pty Limited  
Yarra Falls  
452 Johnston Street  
Abbotsford Vic 3067 Australia  
or to any member of the ASX or POMSOX so as to be received by the Registrar no later than 5.00pm on 27 June, 2005.

OR

#### B. Sale of part of entitlement (Rights) and acceptance of the balance

To sell part of your entitlement (Rights) and accept the balance:

- (a) instruct a member of ASX or POMSOX to sell the number of Rights which you wish to renounce. Rights may only be traded in the period between 24 May 2005 and 20 June 2005 on the ASX and POMSOX.
- (b) complete and sign the Security Renunciation Form, ensuring you have included the "Entitlement No." shown on your Entitlement and Acceptance Form;
- (c) complete the enclosed Entitlement and Acceptance Form for the number of New Shares you wish to accept in accordance with the instructions on that form;
- (d) attach your cheque or bank draft (denominated in Australian dollars) made payable to "Cue Energy Resources Limited" and crossed "Not Negotiable" for the amount required to be paid in accordance with the payment instructions set out below; and

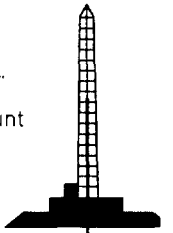

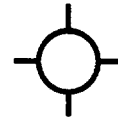

- (e) forward both the completed Security Renunciation Form and your completed Entitlement and Acceptance Form together with your cheque or bank draft to, the member of the ASX or POMSIX whom you instructed to sell the Rights.

If you wish to sell some of your Rights, you must do so before Rights trading ceases.

**OR**

**C. Sale of entitlement in full**

To sell your entitlement (Rights) in full:

- (a) instruct a member of ASX or POMSIX to sell your Rights. Rights may only be traded in the period between 24 May 2005 and 20 June 2005 on ASX and POMSIX;
- (b) complete and sign the Security Renunciation Form, ensuring you have included the "Entitlement No." shown on your Entitlement and Acceptance Form; and send your Entitlement and Acceptance Form, including the completed Security Renunciation Form, promptly to the member of ASX or POMSIX you instructed.

If you wish to sell your entitlement, you must do so before Rights trading ceases.

**OR**

**D. Do nothing**

If you take no action by 5.00pm on 27 June, 2005 your Rights will be forfeited, you will not receive any value residing in your Rights and your shareholding may be diluted. Similarly, if you accept less than your full entitlement and you do not sell the balance of your Rights to subscribe for New Shares, you will not receive any value residing in the Rights not accepted or sold and your shareholding may be diluted.

**PAYMENT INSTRUCTIONS**

The New Shares are payable in full by payment of AUD20 cents per New Share on acceptance.

Payment must be made in Australian dollars by cheque or bank draft, drawn on and payable at any Australian bank.

Cheques or bank drafts are to be made payable to "Cue Energy Resources Limited" and crossed "Not Negotiable".

If you need assistance you should contact a member of the ASX or POMSIX or your financial or legal adviser.

**UNDERWRITING ARRANGEMENTS AND POSSIBLE IMPLICATIONS**

The Issue is underwritten by Todd Petroleum Mining Company Limited (Todd), as to 80%, and Great Missenden Holdings Pty Ltd (Great Missenden) as to 20%. Todd is an associate of both Richard Tweedie, who is Managing Director of Todd, and of Kenneth Hoolihan, Exploration Manager of Todd, both directors of the Company. Todd owns 9.91% of the Ordinary Shares currently on issue in Cue Energy Resources. Great Missenden is controlled by Geoffrey Albers, a director and substantial shareholder of the Company. The terms of the underwriting provide that Todd and Great Missenden will receive commission of 5% of the total amount raised making a total payment of approximately \$871,000. Given that the New Shares will represent approximately 16.6% of the expanded share capital of Cue Energy Resources, should it eventuate that none of the members' entitlements to New Shares is taken up, then Todd would, through the underwriting, be required to subscribe for 80% of all of the New Shares which would result in it holding approximately 21% of the expanded share capital. Great Missenden is not presently a shareholder of the Company. In the event that none of the members' entitlements were taken up, then Great Missenden would through the underwriting, be required to subscribe for 20% of the New Shares, which would result in Great Missenden holding 3.3% of the expanded capital.



Mr. Albers relevant interest would on this basis, increase to 11.5%. A smaller shortfall would mean a smaller underwriting obligation and result in a correspondingly smaller increase in Todd's and Great Missenden's percentage holding of Ordinary Shares.

The underwriting agreement with Todd and Great Missenden is unconditional save for the requirement that the Prospectus be issued and lodged by the Company and that no stop order in relation thereto is made by the ASIC.

Todd is New Zealand's largest locally owned producer of oil and gas. It has a predominant focus in oil and gas production and exploration. It has significant interests in electricity generation and gas distribution and retail.

#### **TAXATION AND STAMP DUTY IMPLICATIONS**

Applicants should seek their own respective independent advice in relation to matters relating to the operation of taxation and stamp duty laws in their respective countries of domicile.

The Company is unable to give advice on taxation matters generally, as each applicant's position will relate to their own specific circumstances and to the laws of the country of residence.

Applicants should satisfy themselves of possible taxation consequences of purchases and sales of securities by consulting their own professional tax advisors.

#### **TREATMENT OF OVERSEAS SHAREHOLDERS**

The Offer is being made to Eligible Shareholders only. Eligible Shareholders are holders of Ordinary Shares registered at 5.00pm on the Record Date with a registered address in Australia, New Zealand, Papua New Guinea or Singapore.

In accordance with the Listing Rules of the ASX, Cue Energy Resources has decided that it would be unreasonable to extend this offer to shareholders with registered addresses in countries other than Australia, New Zealand, Papua New Guinea and Singapore, having regard to:

- the number of shareholders resident in those countries;
- the number and value of New Shares that would be offered under the Offer to shareholders resident in those countries; and
- the cost of complying with the legal requirements, and the requirements of regulatory authorities, in those countries.

However, in accordance with the Listing Rules of the ASX, arrangements have been made for the entitlement (Rights) of shareholders registered addresses in countries other than Australia, New Zealand, Papua New Guinea and Singapore to be sold by a nominee for such shareholders (appointed by the Directors), provided there is a viable market in the Rights and a premium over the expenses of sale can be obtained.

Any sale by the nominee will be effected promptly after the Record Date. The ability to sell those Rights and the price obtained for those Rights are dependent on market conditions. The net proceeds of the sale, after deducting brokerage, will be sent to each of the shareholders for whose benefit the Rights have been sold, in proportion to their respective shareholding.

To the maximum extent permitted by law, Cue Energy Resources and the nominee will not be subject to any liability, including liability for negligence, for failure to sell Rights or to sell Rights at any particular price.

If there is not a viable market for those Rights or no value can be obtained for them, after deducting brokerage, they will be allowed to lapse.

Shareholders with registered addresses in Australia, New Zealand, Papua New Guinea and Singapore holding existing Ordinary Shares on behalf of persons who are resident overseas are responsible for ensuring that taking up their Rights does not breach the laws of the relevant overseas jurisdiction. The return of a duly completed Entitlement and Acceptance Form will constitute a representation by the applicant that there has been no breach of any such laws.

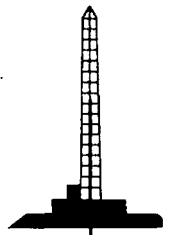

## IMPORTANT INFORMATION

### IMPORTANT DATES (estimate only)

Rights trading commences on the ASX and POMSOX and shares trade ("ex Rights")	24 May 2005
Record date for calculation of entitlements (5.00pm)	30 May 2005
Opening date	6 June 2005
Quotation and trading of Rights ceases on ASX and POMSOX	20 June 2005
Closing date and time for receipt of acceptances and Renunciations with payment of the issue price (5.00pm)	27 June 2005
Allotment of New Securities (no later than)	30 June 2005
Expected date of issue of Shareholder Statements	4 July 2005

### ANSWERS TO IMPORTANT QUESTIONS:

#### What sort of investment is this?

Shares are a means by which you can participate in the ownership of a company. By purchasing a share you become a part owner of the company. There are currently 435,443,755 fully paid Cue Energy Resources Ordinary Shares on issue. This offer is your opportunity to purchase more.

Cue Energy Resources is offering holders of existing Shares, on a pro rata entitlement basis, one Ordinary Share for every five Ordinary Shares held, amounting in aggregate to a further 87,088,751 New Shares. This will result in 522,532,506 Ordinary Shares being on issue, post completion of the offer.

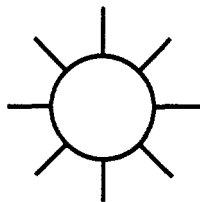

The New Shares are being offered on a renounceable pro rata entitlement basis. This means that Eligible Shareholders may accept their entitlements either in full or in part. An Eligible Shareholder who does not wish to accept their entitlement or wishes to accept it in part only may sell or transfer either in full or in part that portion of the entitlement (Rights) which the Eligible Shareholder does not wish to accept.

Applications will be made for the Rights to be quoted on ASX and POMSOX. Subject to approval of ASX and POMSOX, trading in Rights will commence on ASX and POMSOX on 24 May 2005.

New Shares will rank equally with other Ordinary Shares. Each New Share entitles the holder to:

- be present in person or by proxy, representative or attorney at a general meeting of Cue Energy Resources and have one vote on a poll for each fully paid Ordinary Share held on resolutions at a general meeting;
- an equal participation with other Ordinary Shares in any dividend declared by Cue Energy Resources;
- an equal participation with other Ordinary Shares in the residual assets on liquidation of Cue Energy Resources;
- be sent reports, notices of meetings and other information sent to Shareholders;
- transfer their Ordinary Shares by an instrument in writing in any usual form or in any other form that the directors approve, or by a proper transfer effected in accordance with the rules of the relevant stock exchange; and
- any other rights of a Shareholder conferred by the Constitution and the Corporations Act 2001.

Further details of the rights and obligations of Shareholders are set out in the Constitution.

### **Who is involved in providing it for me?**

The issuer of the Rights and of the New Shares is Cue Energy Resources Limited, Level 25, 500 Collins Street Melbourne Australia. Cue Energy Resources is listed on ASX and POMSOX.

The principal activities of the Company are set out on pages 15 to 24 of this Prospectus.

The company was incorporated in New Zealand in 1981 to explore for hydrocarbons. The company acquired its interest in the SE Gobe oil discovery in 1995, in the Sampang PSC (which contains the Oyong and Jeruk fields) in 1997 and in the Maari oil field in 2005. In early 2005, the Company transferred incorporation out of New Zealand and reincorporated in Australia.

### **How much do I pay?**

Each New Share is to be issued at AUD20 cents, to be paid in full and in Australian dollars on application.

There is no minimum investment amount and the Directors have not set a minimum level of subscriptions for the issue to proceed.

Application must be made on the Entitlement and Application Form accompanying this Prospectus and forwarded, with payment in full, to Cue Energy Resources Limited, C/- Computershare Investor Services Pty Limited at GPO Box 52, Melbourne, Victoria 8060, Australia, no later than 5.00pm on 27 June 2005, which is the Closing Date for the Offer. All cheques must be made payable to Cue Energy Resources Limited and crossed "Not Negotiable". The application instructions are set out in the Entitlement and Acceptance Forms accompanying this Prospectus.

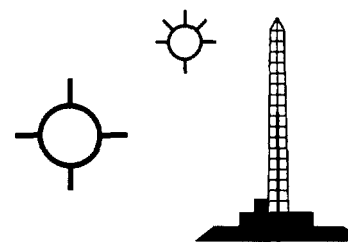

The New Shares will be allotted and CHESSE statements sent to subscribers as soon as practicable after the Offer closes but, in any event, allotment is expected to be completed not later than 30 June 2005.

#### **What are the charges?**

There are no charges to be paid by investors associated with this Offer. Cue Energy Resources will pay all costs in connection with the Offer including management fees, printing, posting, legal fees, share registry expenses and ASX and POMSOX fees. If you wish to sell any Rights to New Securities, you may be required to pay brokerage to the sharebroker who organises such sale for you (such charges are set by the sharebroker).

#### **What returns will I get?**

##### ***Rights***

Eligible Shareholders at the Record Date (30 May 2005 ) are offered the Rights at no cost. Applications will be made for the Rights to be quoted on ASX and POMSOX. Subject to approval of ASX and POMSOX, Rights trading on ASX and POMSOX will take place between 24 May 2005 and 20 June 2005.

Eligible Shareholders may take the following action with respect to Rights:

- Accept your entitlement in full; or
- Sell part of your entitlement (Rights) and accept the balance; or
- Sell your entitlement (Rights) in full; or
- Do nothing and forfeit your Rights.

The return (if any) from selling Rights will depend on the price at which those Rights can be sold on ASX or POMSOX assuming a listing of the Rights is granted on those exchanges. That price will in turn be influenced by the price at which Ordinary Shares are able to be sold on the relevant exchange. Some factors affecting the price of Ordinary Shares are described below.

None of Cue Energy Resources, the Directors, or any person associated with the Offer, guarantees or promises any return from the Rights. If you sell your Rights, the person legally liable to pay the return you will receive from the Rights is the person who buys them from you.

##### ***New Shares***

New Shares issued as a result of this Offer will rank equally, including as to dividends and voting, with the existing Ordinary Shares already on issue.

##### ***Dividends***

Shareholders' return on the New Shares will include any dividends declared by Cue Energy Resources after the issue of the New Shares. Dividends may be subject to tax.

Any dividends to be paid by Cue Energy Resources will be prudently set by the Directors having regard to factors affecting the Company's existing and future financial and operational performance taking into account factors such as general trading conditions, present and future competition and key input costs such as labour and general operating costs. If dividends are declared, Cue Energy Resources is legally liable to pay these.

##### ***Sale of New Ordinary Shares***

If a decision is made to sell the New Shares, a shareholder's returns will depend on a number of factors, many of which are not within the Company's control. If you sell your New Shares, the person legally liable to pay the returns you will receive from the New Shares is the person who buys them from you.



Some factors which may have an influence on the price of Cue Energy Resources' Ordinary Shares are:

- the results of exploration and the costs of exploration and development;
- material changes in oil and gas prices;
- material changes in the value of the Australian dollar against all currencies;
- the level of interest rates;
- the performance of the New Zealand, Australian, Papua New Guinea and Indonesian economies;
- disruption to Cue Energy Resources' oil and gas operations;
- acts of terrorism; and
- the occurrence of political or trade disputes in the regions where the Company operates.

None of Cue Energy Resources, the Directors or any person associated with the Offer guarantees the New Shares, or guarantees or promises that a dividend will be paid on the New Shares, or that the issue price will be recouped.

#### **What are my risks?**

No investment is risk free. The key to investment is understanding the nature of the risk and determining whether it is appropriate for you in meeting your investment needs. This Offer does not guarantee or promise you any return.

The principal risks for an investor are:

- not recovering in full the money paid for the New Shares and
- not receiving the returns discussed under the heading "What returns will I get?".

Various factors will affect these principal risks, including:

- expenditure on exploration and resulting success or lack of success;

- the effect of competition, market conditions, oil price and the depletion of oil reserves on the ongoing profitability of Cue Energy Resources' business;
- a lack of liquidity (i.e. buyers and sellers) in the market for Cue Energy Resources Ordinary Shares;
- market value of Cue Energy Resources' assets;
- a negative share market perception of Cue Energy Resources and/or the industry it is in;
- increased expenditure on the Oyong oil and gas development in the Sampang production sharing contract ("PSC") area. The Oyong oil and gas development is discussed further on page 19;
- mergers, joint ventures or acquisitions made by Cue Energy Resources which may adversely impact on the position/perception of Cue Energy Resources in the share market;
- changes to government policy, taxation or regulation in Australia, New Zealand, Papua New Guinea and Indonesia, particularly in relation to oil and gas exploration and production;
- the Indonesian authorities not giving the requisite approvals in respect of the development of Oyong by Cue Energy Resources and the other Joint Venture Parties. This is discussed in more detail on page 24;
- the Jeruk appraisal programme not being successful or being less successful than anticipated;
- the continuing solvency of Cue Energy Resources; and
- blowouts, fires and other disasters in hydrocarbon exploration and production in which Cue Energy Resources is participating.

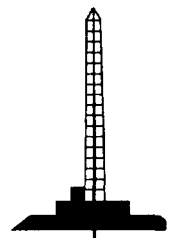
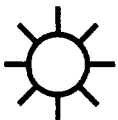

Additional special trade factors that could materially affect the prospects of the Cue Energy Resources Group are set out on page 24.

There is no risk of a subscriber being required to pay more money for the New Shares other than that disclosed above.

It is reasonably foreseeable that if:

- Cue Energy Resources is liquidated and there is insufficient money to repay your original subscription moneys,

you will receive less than the amount paid to Cue Energy Resources under this Offer.

#### **Consequences of Insolvency**

In the event that Cue Energy Resources is put into liquidation or is wound up, all claims of creditors of Cue Energy Resources (such as fees and expenses of any liquidator, wages and salaries of employees, taxes, any moneys owing to any mortgagee or other chargeholder over Cue Energy Resources assets or any trade creditors), will rank ahead of claims by ordinary Shareholders.

After all other creditors have been paid, Ordinary Shareholder claims will rank equally.

In the event of Cue Energy Resources becoming insolvent, you will have no liability to pay any additional money to any person. An exception to this may occur where a dividend has been paid by Cue Energy Resources at a time when Cue Energy Resources did not satisfy the solvency test set out in the Corporations Act 2001. In that case a liquidator may call for the return of the money which made up this dividend.

**This is not an exhaustive list of risks, as many risks may not be foreseeable. You are advised to seek independent advice and consider your own position carefully before you invest.**

#### **Can the investment be altered?**

The rights associated with the New Shares, which are set out under the heading "What sort of investment is this", can only be altered by a special resolution of all Shareholders of Cue Energy Resources in accordance with its Constitution. A special resolution is a resolution approved by a majority of 75% of the votes of those shareholders entitled to vote and voting on the resolution. In limited circumstances, rights can be altered by a Court order.

#### **How do I sell my investment?**

You can sell your New Shares at any time after your New Shares have been issued to you.

If quotation is granted, Rights trading on ASX and POMSOX commences on 24 May 2005 and ceases on 20 June 2005. Should you subsequently wish to sell your New Shares you need to contact any member of ASX or POMSOX who will supply you with a securities transfer form (if necessary).

No charges are payable to Cue Energy Resources in respect of any sale of New Shares and Rights granted, although sales through a broker may incur brokerage fees. Investors can also sell their New Shares and Rights by private treaty.

As the Rights issued are new classes of security, the Directors of Cue Energy Resources are of the opinion that there is no established market for those securities. However the Directors expect that a market for the Rights will develop on ASX and POMSOX assuming that those securities are listed.

In respect of the New Shares the Directors of Cue Energy Resources are of the opinion that there is an established market on ASX and POMSOX.



### **Who do I contact with enquiries about my investment?**

Enquiries about the Rights and the New Shares can be made to:

The Issuer:  
Company Secretary  
Cue Energy Resources Limited  
Level 25, 500 Collins Street  
Melbourne VIC 3000 Australia  
Phone +61 3 9629 7577  
Fax +61 3 9629 7318

Enquiries concerning the details that may be entered on the Share Register should be directed to:

Computershare Investor Services Pty Limited  
Yarra Falls, 452 Johnson Street  
Abbotsford 3067  
General Enquiries 1300 136 219  
Overseas Holders +613 9 415 4262  
Fax +613 9 743 2529

### **Is there anyone to whom I can complain if I have problems with the investment?**

Complaints about the Rights and the New Shares can be made to:

Company Secretary  
Cue Energy Resources Limited  
Level 25, 500 Collins Street  
Melbourne VIC 3000 Australia  
Phone +61 3 9629 7577  
Fax +61 3 9629 7318

There is no ombudsman to whom you can complain in relation to the Rights or the New Shares being offered.

### **What other information can I obtain about this investment?**

Further information about the Rights, New Shares and Cue Energy Resources are contained in this Prospectus and in Cue Energy Resources' financial statements. The most recent financial statements of Cue Energy Resources may be obtained free of charge by contacting the Company at Level 25, 500 Collins Street, Melbourne VIC 3000, Australia and are included on the Cue website [www.cuenrg.com.au](http://www.cuenrg.com.au).

This Prospectus, financial statements and other documents of, or relating to, Cue Energy Resources are filed on a public register at the Australian Securities and Investment Commission and are available for public inspection during normal working hours, on the payment of the prescribed fee.

### **Annual Information**

In addition, as a Shareholder you will receive:

- a copy of the annual report; and
- statements relating to any distributions.

*Cue Energy Resources is also required to make quarterly, half yearly and annual announcements to the ASX and POMSOX and other such announcements as are required by the continuous disclosure rules of those exchanges from time to time.*

On request you can obtain information about your shareholding from Computershare Investor Services Pty Limited at GPO Box 52, Melbourne, Victoria 8060, Australia. No charge will be made for this information.

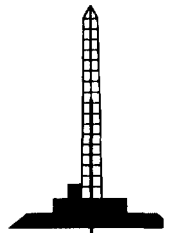

## MAIN TERMS OF THE OFFER

Cue Energy Resources Limited is the issuer of the Rights, New Shares offered under this Prospectus. Cue Energy Resources is an Australian company registered under the Corporations Act 2001 having its registered office at Level 25, 500 Collins Street, Melbourne Australia.

A description of the New Shares being offered is provided on page 10 of this Prospectus.

The New Shares are offered under this Prospectus at a price of AUD20 cents each.

It is intended that this Offer will raise approximately AUD\$17.4 million by the issue of New Shares to replace funds expended on buying back into, and to assist in, further appraisal of the Jeruk oil discovery in the Sampang PSC, Indonesia.

### FUNDING GENERALLY

Cue Energy Resources may require further funds for its programmes. Any such additional funds would be raised in a manner deemed the most expedient by the board of directors at the time, taking into account working capital, exploration results, budgets and sharemarket conditions.

Additional funds for exploration could be raised by any one or a combination of the following manners: placement of shares to excluded offerees, pro-rata issue to shareholders, the exercise of outstanding options, and/or a further issue of shares to the public. Should funds be required for development purposes the Company would, in addition, look to project loan finance.

### OPERATIONS AND PROJECTS

Cue Energy Resources is a company predominantly involved in production of, and exploration for, oil and gas. It currently holds participating interests in oil and gas ventures in Papua New Guinea, Indonesia, Australia and New Zealand. They are described further below.

Most of the developments in which the Company has interests are not mature and can be regarded, together with Cue Energy Resources Group's exploration prospects, as speculative.

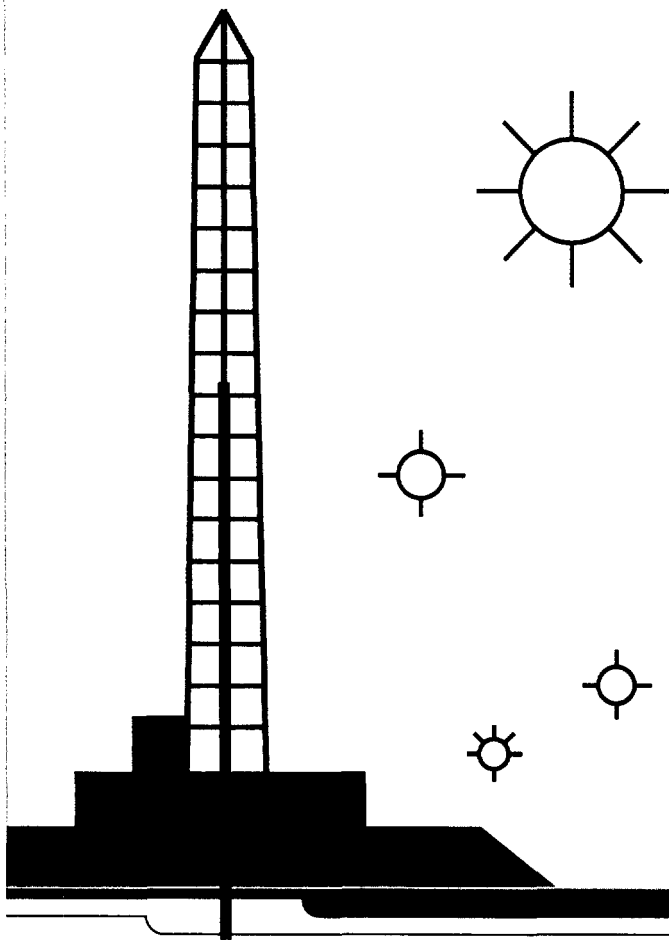

## PAPUA NEW GUINEA

In Papua New Guinea, Cue Energy Resources holds participating interests in the SE Gobe oil field and in three exploration areas (PPL 190, PRL-9 and PRL-8).

At the end of April 2005, the SE Gobe field was producing at a rate of approximately 6,500 barrels of oil per day, Cue Energy Resources share being approximately 250 barrels of oil per day. Over the final quarter of 2004, this share of field oil production resulted in production revenue to Cue of US\$1,026,971. The recent SE Gobe 11 development well will add an estimated 2000 barrels of oil per

day to field oil production. Oil production from the field is expected to continue at a declining level until around 2009.

Exploration drilling in 2003 in PPL190, where Cue Energy Resources holds a 10.947% interest, resulted in a small, currently sub commercial, oil discovery at Bilip -1. In late 2004 and early 2005, a 2D seismic survey was undertaken over the Wasuma trend, the Bilip area and the extension of SE Gobe structural trend to identify a drilling location for a late 2005 exploration well.

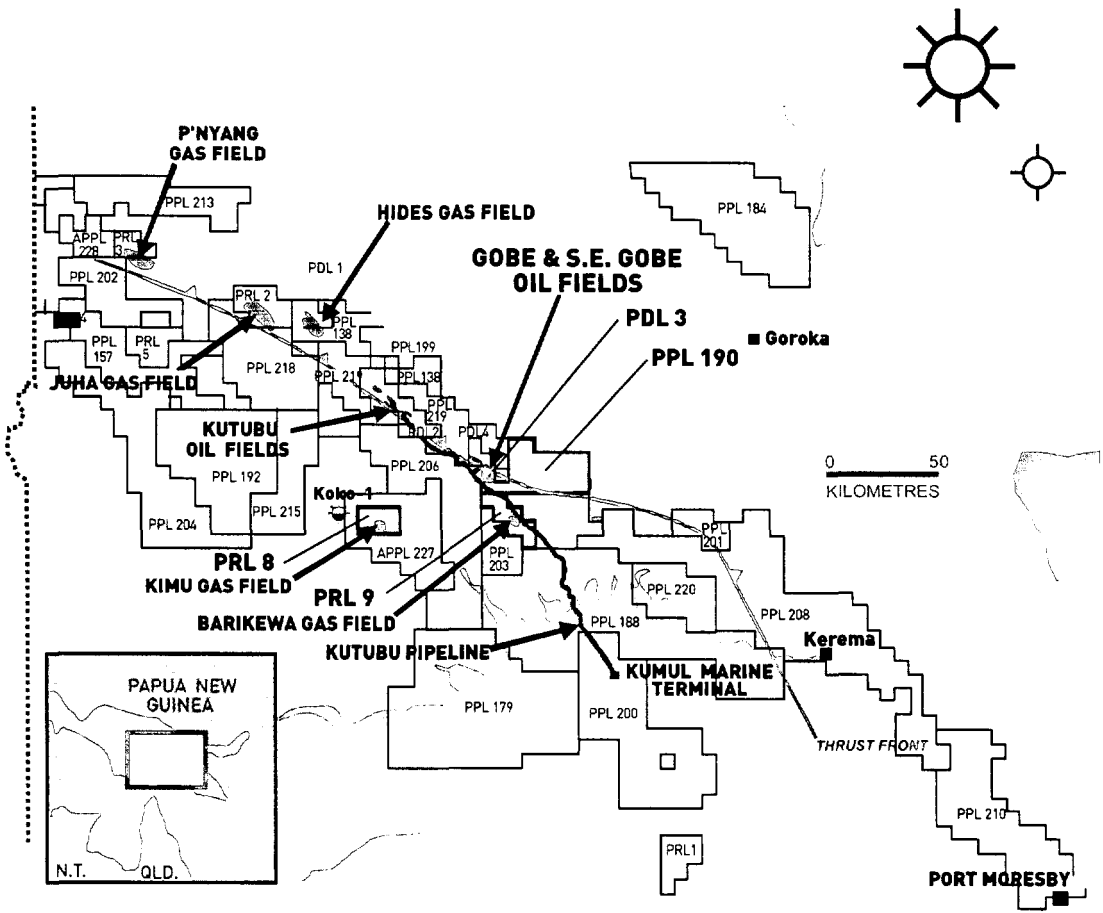

Figure 1. Papua New Guinea Location Map

In PRL -9, where Cue Energy Resources holds a 14.894% interest, the Barikewa gas field is estimated to contain approximately 800 billion cubic feet of recoverable natural gas (Cue Energy Resources share is approximately 120 billion cubic feet). In PRL -8, which contains the Kimu gas field which is estimated to contain approximately 1 trillion cubic feet of recoverable natural gas (Cue Energy Resources share is 110 billion cubic feet), studies have been undertaken to determine the potential to use gas from the field as feedstock for methanol production. Initiatives have been undertaken to export gas to Australia by pipeline; to export compressed natural gas to New Zealand, as well as use the gas as chemical feedstock.

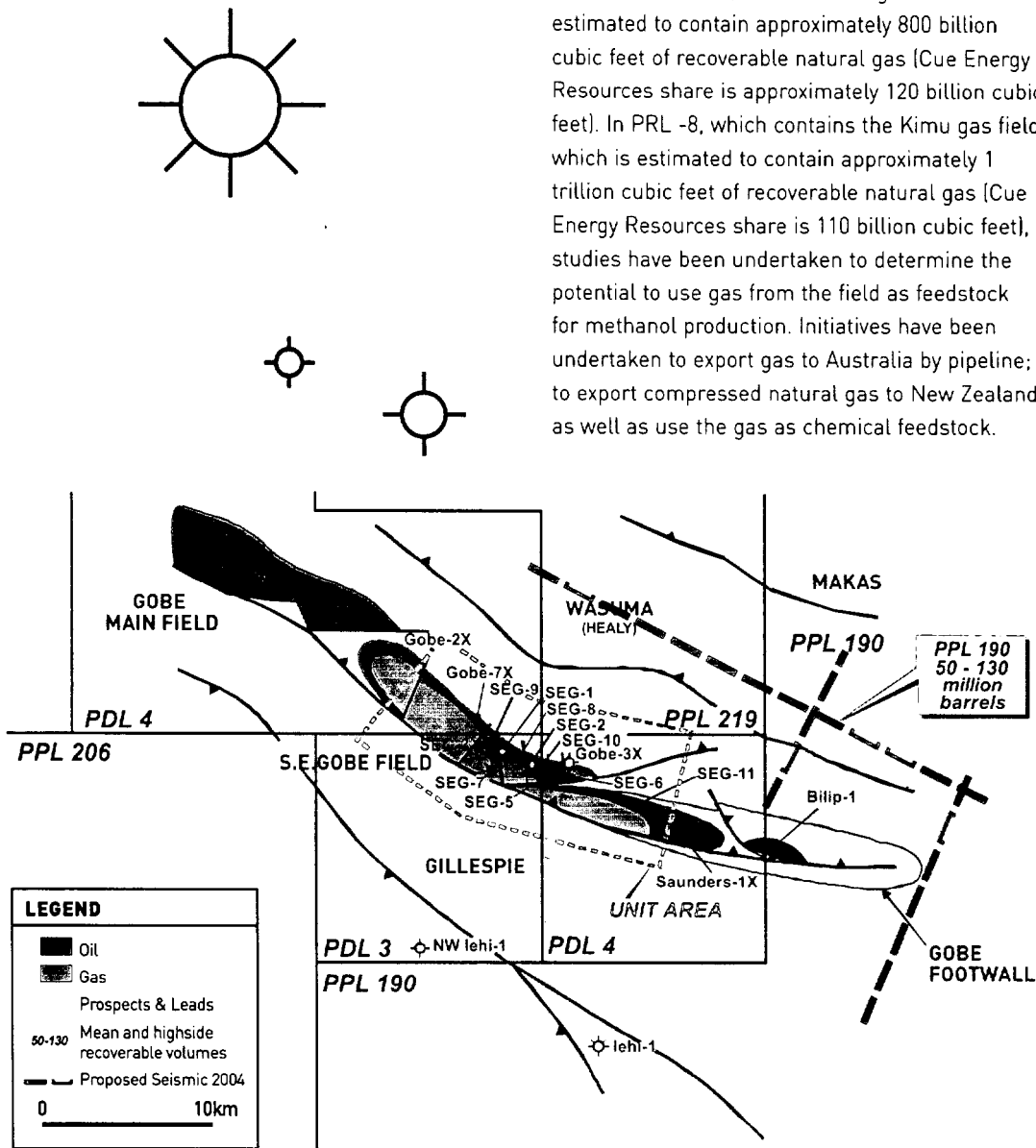

Figure 2. Papua New Guinea S.E. Gobe Area



## INDONESIA

In Indonesia, Cue Energy Resources holds a 15% participating interest in the Sampang PSC Joint Venture ("Joint Venture") which includes the Oyong gas and oil field development and the Jeruk oil discovery.

The Sampang PSC is operated by Santos (Sampang) Pty Ltd on behalf of the Joint Venture with participant equity interests as follows:

- Santos (Sampang) Pty Ltd 45% (Santos group - operator)
- Singapore Petroleum Sampang Ltd 40%
- Cue Sampang Pty Ltd 15%

*(A wholly owned subsidiary of Cue Energy Resources)*

Cue Energy Resources expects that additional exploration drilling will continue in the Sampang PSC area with one wildcat well (a speculative well) anticipated to be drilled in the second half of 2005.

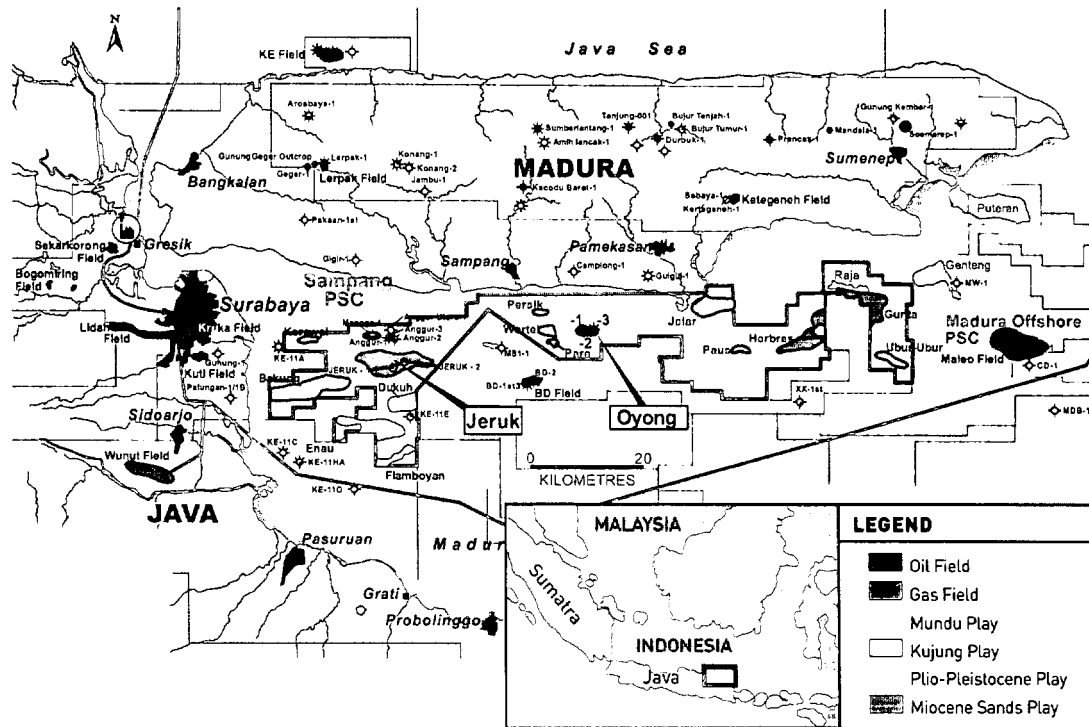

Figure 3. Current Sampang PSC Area Prospects and Leads Map

### Jeruk Oil Discovery

The Jeruk oil discovery is located in the Sampang PSC, offshore East Java, Indonesia, approximately 40 kilometres east of the city of Surabaya (fig 3) in approximately 40 metres water depth.

In April 2004, the Jeruk -1 well tested an oil and water emulsion (up to 80% water) from an open hole test at the top of the carbonate objective at a rate of 4700 barrels per day on a 3/8 inch choke.

The well was drilled on a sole risk basis by Santos. Cue declined to join the sole risk.

In July 2004, Santos began drilling the Jeruk -2 appraisal well approximately 1.6 kilometres east of Jeruk -1. Jeruk -2 was drilled on a sole risk basis by Santos. Cue, again, did not participate in the sole risk.

Jeruk -2 subsequently tested 7488 barrels of 33° API oil per day on a half inch choke over an 18 metre interval from 5134 to 5132 metres measured depth, at the top of the carbonate. The flow was constrained by the throughput capacity of the surface production test facilities.

The well was deepened to 5726 metres measured depth where an open hole test recovered 57 barrels of formation water from poor quality reservoir.

Due to mechanical difficulties, the well was then sidetracked to 5460 metres measured depth and an open hole test run over a 30 metre interval.

Oil, gas and water were recovered, but the flow potential could not be established due to debris in the test string. The qualities of the oil recovered and the pressure data from the test indicated that

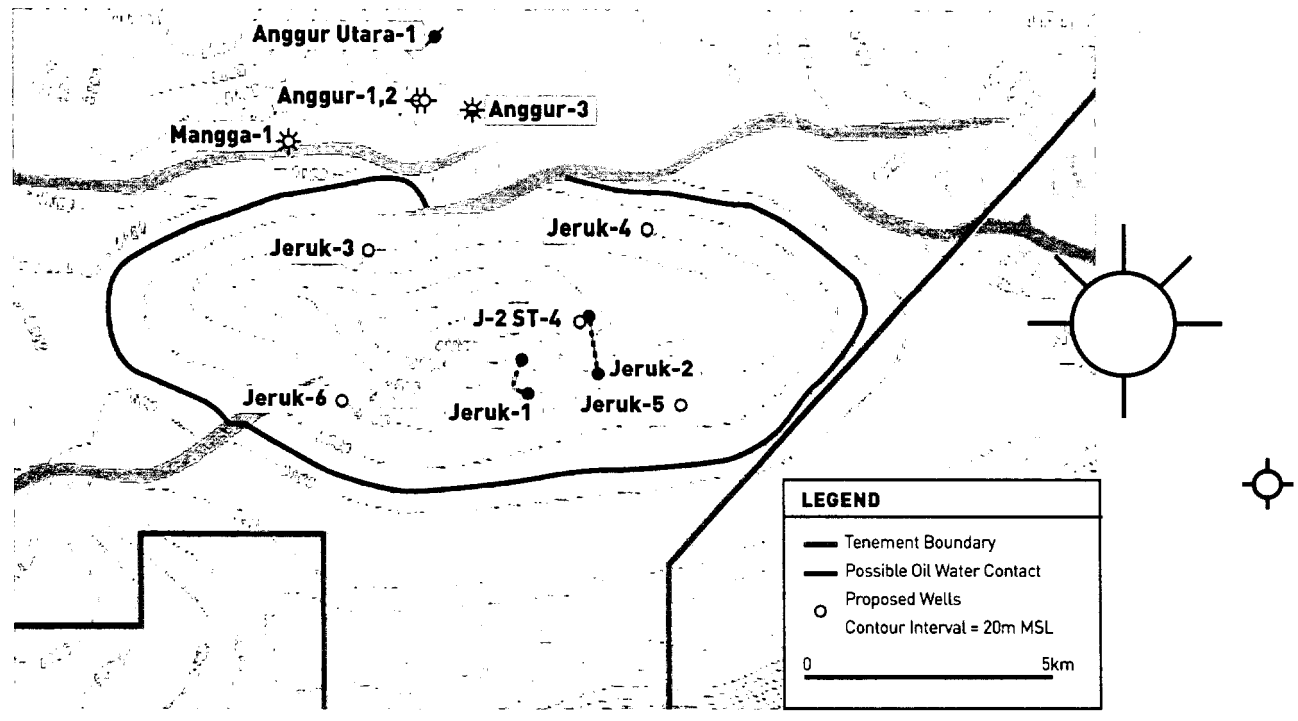

Figure 4. Jeruk Map



the oil is part of the same hydrocarbon column tested by the shallower Jeruk -2 test and that consequently, an oil column of at least 380 metres is likely to be present.

In a release to the ASX on 20 January 2005, the parent of the operator for the Sampang PSC, Santos Limited, advised that likely recoverable oil volumes could indicate an oil accumulation with potential to contain in excess of 170 million barrels of recoverable oil. Further appraisal drilling, integrated with the 3D seismic data which has been acquired and is now being processed, will be required to narrow the potential recoverable oil volumes of the field.

It is proposed to re-enter Jeruk -2 and to sidetrack, core and production test the well, beginning in late May 2005. A further four appraisal wells are planned for late 2005.

After carefully evaluating the results, Cue elected to reinstate its rights in the Jeruk discovery.

By reinstating its rights, Cue is obligated to pay in cash a lump sum amount of approximately US\$8.7 million (AUD\$11 million) which is equivalent to the cost it would have incurred if it had participated in the Jeruk -1 and 2 wells. The lump sum is required to be paid by 29 May 2005

In addition, Cue will be required to pay a premium, but sourced only out of future oil production from Jeruk. The premium is equivalent to ten times Cue's share of Jeruk -1 costs, plus five times Cue's share of Jeruk -2 costs. Cue estimates that this premium will approximate US\$55 million. Cue believes that the potential value of Cue's 15% interest in Jeruk will significantly exceed this premium, which, in any event, will only be paid out of oil production.

Cue has sufficient current cash to pay the lump sum and Jeruk -2 sidetrack, coring and testing costs. However, these funds are required to be replaced to cover anticipated ongoing Oyong and Maari development costs for which these funds had been originally allocated.

## Oyong Field

The Oyong gas and oil field is also located within the Sampang PSC area, offshore East Java and South of Madura Island (Fig 3).

### Oyong Background

The Oyong field was discovered in mid 2001 and has been delineated by a total of three wells. The oil and gas discovery is in 41 metres of water approximately 8 kilometres south of Madura Island and has a gas column of approximately 120 metres, underlain by a 38 metre oil column.

On July 19, 2003 a gas sales agreement was signed by the Joint Venture with PT Indonesia Power for the entire gas reserves of the Oyong field. The sale is denominated in US dollars. The gas is contracted to be supplied to the power station at Grati, East Java at a production rate of 40-60 million cubic feet of gas per day over a 7-10 year period.

It is estimated that reserves are:

### Million Barrels

	PROVEN (1P)	PROVEN + PROBABLE (2P)	PROVEN + PROBABLE + POSSIBLE (3P)
<b>Oil</b>			
Oil in Place	80	99	131
Recoverable	6.4	9.9	15.7

### Billion Cubic Feet

#### Gas (including solution gas)

Gas in place	143	169	183
Recoverable	107	135	147

The recoverable gas volumes do not allow for fuel and flare volumes.

Ongoing studies by the operator suggest that recoverable oil volumes are likely to be greater than the certified volumes.

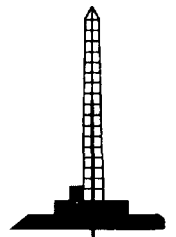

### Oyong Development

As a result of an increase in Oyong field recoverable oil estimates and high crude oil prices, the Joint Venture approved Oyong development plan has been modified to bring forward first oil production to fourth quarter 2005.

The new development will consist of a simple well head structure formed by triangular braced well conductors which will extend above the sea surface from a sea floor tall template structure. Seven oil and gas development wells are planned to be drilled through and between the conductors.

Oil and gas will be processed on a nearby moored barge. Oil will be exported by tanker and gas will be sent by pipeline to the P.T. Indonesia Power electricity generating station at Grati under the existing contract.

First gas is expected around end 2006. Solution gas associated with the early oil production will be reinjected until gas production begins to Grati.

Analysis of the Mundu Formation reservoir rock properties and consequent revised dynamic reservoir simulation modelling, has indicated that the initial oil production rate should reach 20,000 barrels of oil per day for a six horizontal oil wells development.

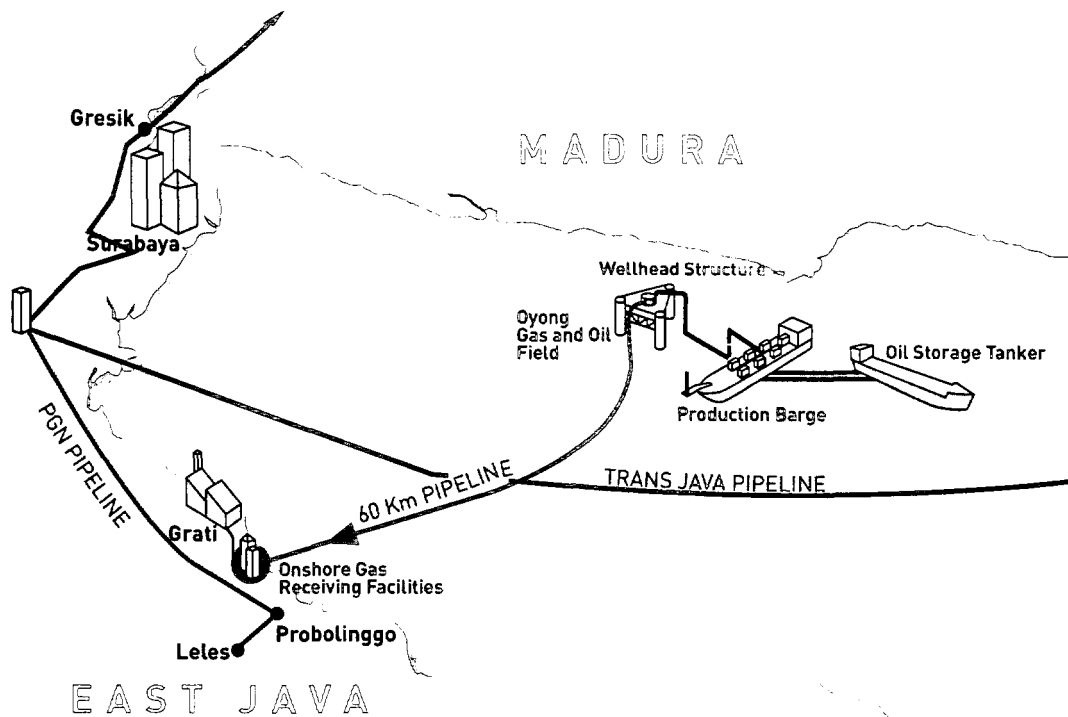
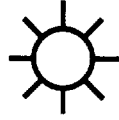

Figure 5. Oyong Development Concept







### **Development Progress**

In April 2005, the revised plan of development for the field was approved by the Indonesian authorities and field development formally began.

Approval of the environmental plan is expected shortly.

The well head platform was completed in mid April 2005 and installation, using the Ocean Sovereign jackup rig, began in the first week of May 2005.

Development well drilling will follow platform installation and is expected to be completed around September 2005.

### **Oyong Development Costs**

Project development costs are expected to be US\$112 million. Cue Energy Resources' share would be US\$17 million (AUD\$22 million at AUD versus USD exchange rate of 0.78).

The requirement for securitization of gas sales payments has been reduced, as the increased oil revenue due to higher proven reserves and increased oil prices are expected to substantially cover the cost of development. Negotiations on securitizing gas payments under the Gas Sales Agreement are still continuing.

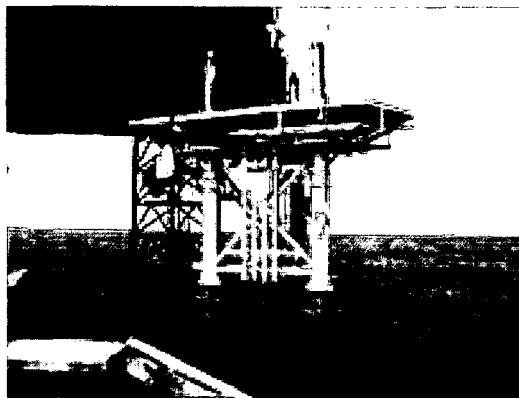
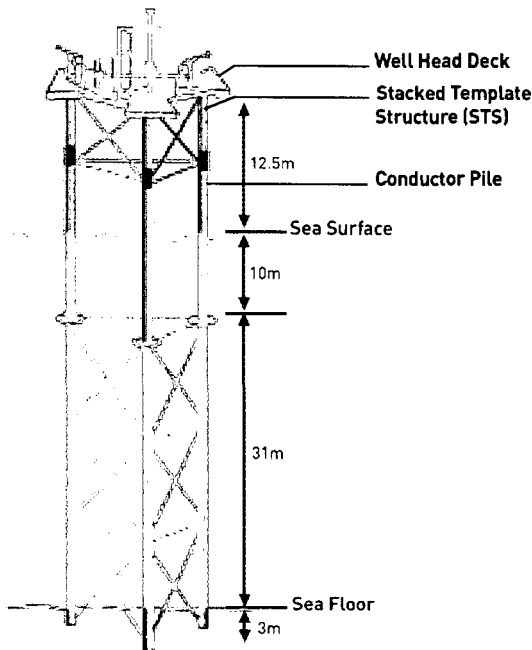

**Figure 6. Well Head Platform**

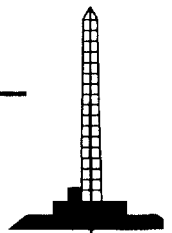

**NEW ZEALAND**

In March 2005, Cue announced the purchase by Cue of Delta Oil Taranaki Pty Ltd's 5% interest in PEP 38413, the permit that contains the Maari oil field in the offshore Taranaki Basin, New Zealand.

Todd Petroleum Mining Company Limited, a company associated with Cue directors, Mr. R. Tweedie and Mr. K. Hoolihan, holds a 16% interest in the permit.

The purchase price was AUD\$6.2 million; which represents AUD\$2.48 per barrel for the 2.5 million barrels of P50 recoverable oil volumes for the Maari field attributable to Cue.

The Maari field, situated in 100 metres water depth, approximately 80km from the Taranaki coast, is the largest undeveloped offshore oil field in New Zealand. The field was discovered by the Moki -1 exploration well, drilled by Tricentrol (operator) and Cue Energy Resources in 1983 and

has been the subject of a number of subsequent delineation wells. Total P50 Moki formation recoverable oil volumes in the field are estimated to be approximately 50 million barrels.

**Maari Development**

The possible development is likely to consist of a platform, with oil and associated gas being produced to a floating production oil storage vessel (FPSO), from which the oil will be exported by tanker.

It is expected that a development decision will be made later in 2005, with first oil production likely in mid 2007, at an initial production rate of around 30,000 barrels of oil per day (gross), with Cue's share being 1500 barrels of oil per day.

PEP 38413 also contains the smaller Manaia oil discovery, which may be developed in the future.

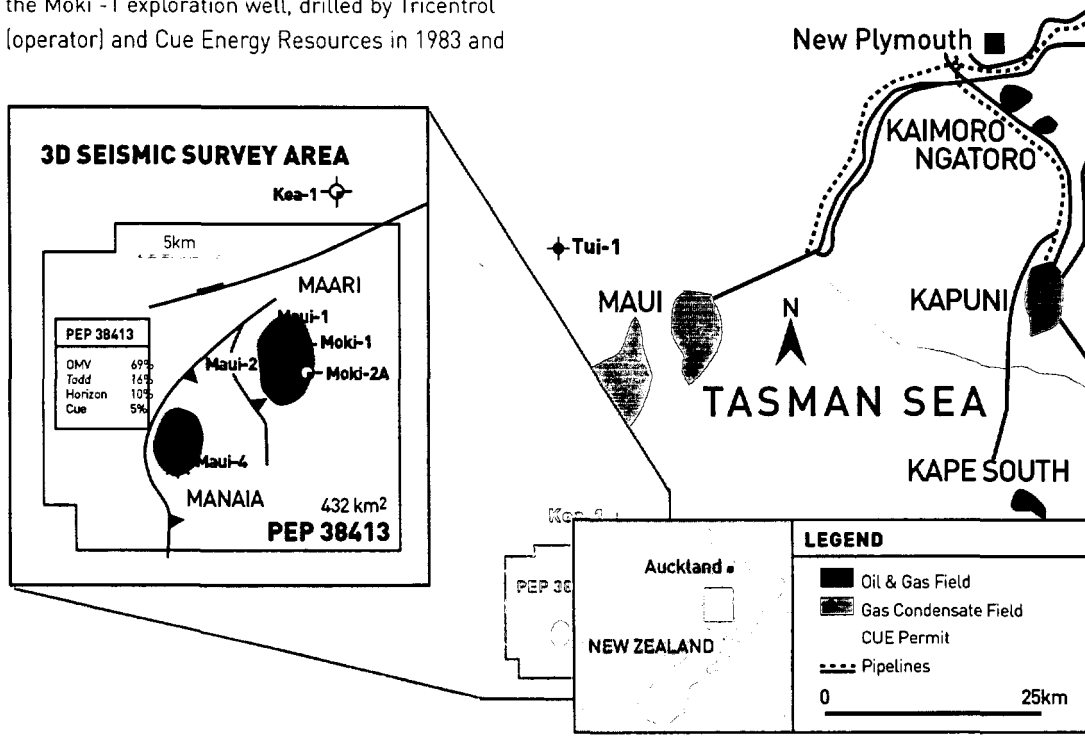

Figure 7. Maari Development

## AUSTRALIA

In late 2004 and early 2005, Cue Energy Resources was granted five offshore permits with two other parties associated with Mr. E.G. Albers, a director of Cue; two in the Bass Basin north of Tasmania and three in the Carnarvon Basin.

The two Bass Basin permits, T/37P and T/38P, are immediately adjacent to the Yolla/Gas condensate field which will begin production in mid 2005. T/38P contains the Pelican gas discovery which merits further study. Cue holds a 50% interest in each permit and will be the operator.

In the first two permit years, the existing technical data will be re-evaluated, ahead of planned 3D seismic surveys in the third year.

Two of the three Carnarvon Basin permits, WA360P and WA361P, are adjacent to the giant Rankin trend producing gas fields. The third permit, WA359P, is adjacent to the Exeter and Mutineer oil fields, which began oil production earlier in 2005. Cue holds a 50% interest in each permit and will be the operator. Despite their strategic location, the permits have only been lightly explored with wells.

In the first two years of each permit, the existing technical data will be re-evaluated to be followed by acquisition of new seismic data in permit year 3.

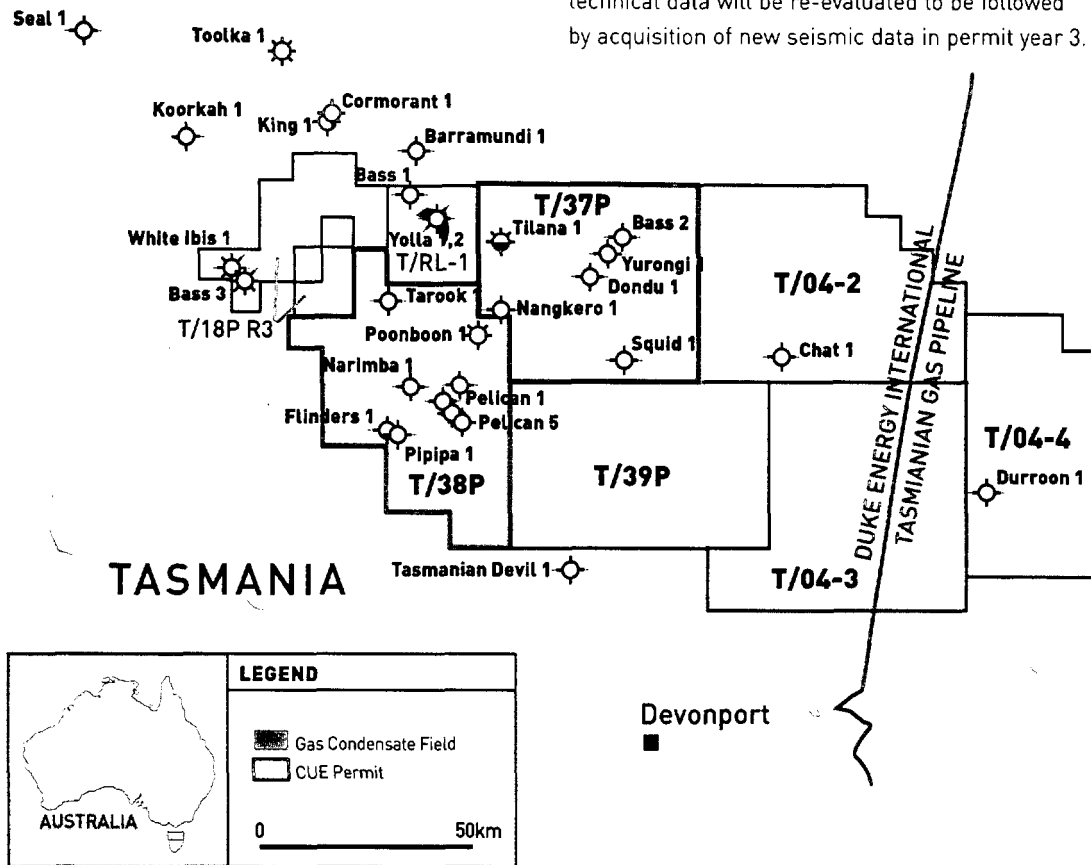

Figure 8. Bass Basin





- The Maari development may prove to be less commercially positive than expected or development may be delayed.

Other risk factors associated with this Issue are detailed on page 11 of this Prospectus.

### **PRELIMINARY AND ISSUE EXPENSES**

The estimated amount of the issue expenses is AUD\$960,000. This will cover management fees, printing, postage, underwriting, legal fees, share registry expenses, ASX and POMSOX fees. No commission is payable in respect of this Offer.

### **OTHER TERMS OF OFFER AND SECURITIES**

All other terms of the Offer, and all terms of the Rights and New Shares being offered (except those implied by law and those contained in Cue Energy Resources' Constitution), are set out in this Prospectus.

### **AVAILABILITY OF FINANCIAL STATEMENTS**

The most recent independently reviewed financial statements of Cue Energy Resources were prepared as at 31 December 2004, and are contained in Cue Energy Resources' Half Yearly Report.

Copies of the Half Yearly Report and financial statements referred to in the preceding paragraph can be obtained free of charge on request by any person to whom this Offer is made, at the registered office of Cue Energy Resources at the offices of Level 25, 500 Collins Street Melbourne Australia and are posted on the Cue website [www.cuenrg.com.au](http://www.cuenrg.com.au).

### **ADDITIONAL INFORMATION**

Special content rules for this Prospectus  
Cue Energy Resources is a 'disclosing entity' for the purposes of the Corporations Act 2001 and, as such, is subject to regular reporting and disclosure requirements.

Normally a Prospectus for the issue of securities of a company must contain all the information that investors and their professional advisers

would reasonably require to make an informed assessment of each of the following:

- assets and liabilities, financial position and performance, profits and losses and prospects of the company that is to issue the securities; and
- the rights and liabilities attaching to the securities offered.

However, in reliance on section 713 of the Corporation Act 2001, this Prospectus does not comply with the general disclosure test. Under section 713 the disclosure test applicable to any company offering:

- shares in a class of shares that have been quoted on ASX at all times in the 12 months before the date of the Prospectus; or is a lower level of disclosure.

The lower level of disclosure, which applies to this Prospectus, is that the Prospectus must contain all the information investors and their professional advisers would reasonably require to make an informed assessment of:

- the effect of the offer on Cue Energy Resources; and
- the rights and liabilities attaching to the securities offered.

The Prospectus must contain this information only to the extent to which it is reasonable for investors and their professional advisers to expect to find the information in the Prospectus.

### **Copies of documents**

Copies of documents lodged at ASIC in relation to Cue Energy Resources may be obtained from, or inspected at, an office of ASIC.

ASX maintains detailed records of company announcements for all companies listed on the ASX. Copies of announcements made by Cue Energy Resources may be obtained from the ASX.

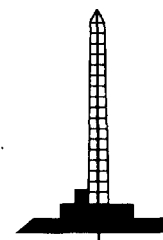

Cue Energy will provide a copy of the following documents, free of charge, to any person who asks for a copy during the application period for this Prospectus:

- the annual financial report of Cue Energy Resources for the year ended 30 June 2004, being the financial report most recently lodged with ASIC by Cue Energy Resources;
- the half-year financial report of Cue Energy Resources for the six months ended 31 December 2004;
- any continuous disclosure notices (that is, documents used to notify ASX of information relating to Cue Energy Resources) given by Cue Energy Resources after lodgement of the annual financial report for the year ended 30 June 2004 and before lodgement of this Prospectus with ASIC. Appendix A contains a list of such notices that are available; and
- the Constitution of Cue Energy Resources.

#### Interests of Directors

Other than as set out below or elsewhere in this Prospectus:

- no director has, or has had in the two years before lodgement of this Prospectus, an interest in the promotion of Cue Energy Resources of, or in any property acquired or proposed to be acquired by Cue Energy Resources in connection with its promotion of the Offer, or the Offer itself; and
- no director has, or has had in the two years prior to lodgement of this Prospectus with ASIC, an interest in:
- the formation or promotion of Cue Energy Resources;
- any property acquired, or proposed to be acquired, by Cue Energy Resources in connection with its formation or promotion of the Offer; or

- the Offer; and
- no amounts have been paid or agreed to be paid and no value or other benefit has been given or agreed to be given to any director, proposed director (or any entity in which either may be a partner or director) either to induce him or her to become, or to qualify him or her as, a director or otherwise for services rendered by him, her or it in connection with the Offer or the promotion of Cue Energy Resources.

#### Contracts

Mr E.G. Albers, a director of the Company, has a substantial shareholding in and is a director of Exoil Limited which is a 50% joint venturer with Cue Energy Resources in respect to the Bass Basin permits, T37P and T38P, and the Carnarvon Basin Permit WA-359-P. In addition, Mr Albers is a director and substantial shareholder of Gascorp Australia Ltd which is a 50% joint venturer with the Company in the Carnarvon Basin permits WA-360-P and WA-361-P.

Mr. R. Tweedie and Mr. K. Hoolihan, directors of Cue, are executives of Todd Petroleum Mining Company Limited (Todd), a company that has a 16% interest in PEP 38413 in the Taranaki Basin, New Zealand. Cue, as a result of its purchase of Delta Oil Taranaki Pty Ltd's 5% interest in PEP 38413, assumed the obligation to pay to Todd a royalty of US\$0.20 (plus GST) per barrel of crude oil produced from PEP 38413.

#### Interests in Shares

The Directors' relevant interests in Ordinary Shares (as defined in the Corporations Act 2001) as at the date of this Prospectus were as follows:

DIRECTOR	DIRECT	INDIRECT	TOTAL
*R. Tweedie	1,679,673	43,210,766	44,890,439
E.G. Albers	6,309,283	36,686,156	42,995,439
*K. Hoolihan	1,191,144	43,210,766	44,401,910
L. Musca	982,820	11,039,225	12,022,045

\* The relevant interests for Mr. R. Tweedie and Mr. K. Hoolihan include 43,057,758 shares held by Todd.

The holders of Ordinary Shares in which Directors have relevant interests will be entitled to participate in the Offer and are entitled to their pro-rata allocation.

### **Remuneration**

The Constitution contains several provisions as to remuneration of Directors. As remuneration for services, each Director is to be paid an amount determined by the Board, subject to a maximum aggregate amount for non executive Directors of AUD\$210,000 per annum. Any Director who devotes special attention to the Company's business, or who otherwise performs services which in the opinion of the Board are outside the scope of the ordinary duties of a Director or who, at the request of the Board, engages in any journey on the business of the Company, may be paid a fee for the services as determined by the Board.

In addition, every Director is entitled to be paid all reasonable travel, accommodation and other expenses incurred by the Director in attending meetings of the Company, the Board or of any committees or while engaged in the business of the Company.

### **Underwriting Fees and Commission**

As previously disclosed, both Mr. R.G. Tweedie and Mr. K. Hoolihan are officers of Todd Petroleum Mining Company Limited, an underwriter, but will not directly participate in or benefit from payment of those underwriting fees to the extent received by that entity. Mr E.G. Albers is a shareholder and director of Great Missenden Holdings Pty Ltd, an underwriter, and will indirectly benefit from payment of those underwriting fees to the extent received by that entity.

### **Interests and Consents of Experts and Other Persons**

PKF has given and has not, at the date of this Prospectus, withdrawn its consent to being named in this Prospectus as auditor to Cue Energy Resources Limited in the form and context in

which it is so named and to the issue of the Prospectus with references to the Financial Report for the 6 months ended 31 December 2004 in the form and context in which those references are so included. Other than referred to above, PKF was not involved in the preparation of any part of the Prospectus and has not authorised or caused the issue of any part of this Prospectus.

Computershare Investor Services Pty Limited has given and has not, at the date of this Prospectus, withdrawn its written consent to being named in the Prospectus as the Share Registrar of the Company in the form and context in which it is named. Computershare Registrar Services Limited has not participated in the preparation of the Prospectus and has only authorised or caused the issue of those parts of the Prospectus which comprise references to it as the Share Registrar of the Company in the form and context in which those references are included.

Each of Todd Petroleum Mining Company Ltd and Great Missenden Holdings Pty Ltd has given and has not, at the date of this Prospectus, withdrawn its consent to being named in the Prospectus as the Underwriters of the New Shares offered by this Prospectus in the form and interest in which it is named. They have not participated in the preparation of the Prospectus and have only authorised or caused the issue of those parts of the Prospectus which comprise reference to them as the Underwriters in the form and context in which those references are included.

### **Consent to Lodgement**

Every Director has consented to the lodgement of this Prospectus with ASIC under the Corporations Act.

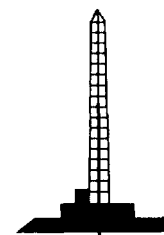
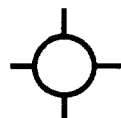

# CAPITAL STRUCTURE AND EFFECT OF THE ISSUE ON THE COMPANY

## 1. CAPITAL STRUCTURE

### 1.1 Existing Capital Structure

The existing capital structure comprises:

- (a) 435,443,755 ordinary shares;
- (b) 3,000,000 executive options, as set out in the table, immediately below.

Number	Exercise Price	Expiry Date
500,000	12 cents	02/05/06
500,000	15 cents	02/05/06
1,000,000	30 cents	02/05/06
1,000,000	35 cents	02/05/07

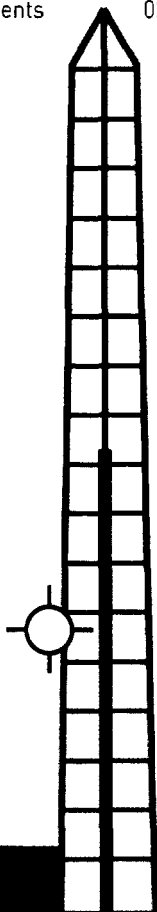
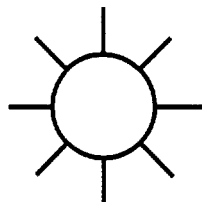

### 1.2 Capital Structure on Completion of the Public Issue

On the issue and allotment of all shares pursuant to this Prospectus, on the assumption that the Offer is fully subscribed, the ordinary share capital of the Company will have increased to 522,532,506 shares, of which 87,088,751 ordinary shares will be issued pursuant to this Prospectus.

## 2. EFFECT OF THE ISSUE ON THE COMPANY

The principal effects of the Issue on the Company will be that if the Issue is fully subscribed then:

- 2.1 the Company will raise an amount of \$17,417,750 (less the costs of the Issue). In addition, the receipt of the subscription moneys will alter the net asset backing of each share on issue in the capital of the Company.
- 2.2 the capital of the Company will be increased by a total of 87,088,751 shares.

The effect of the Issue on the Statement of Financial Position of the Company is set out below. The Pro-forma Statement of Financial Position is based on the Company's half-year Financial report which was reviewed by the Company's auditor. The placement in February 2005 of 60 million shares at 30 cents less costs, has also been included in the proforma. The Pro-forma statement assumes that this Issue is fully subscribed, that the costs of the Issue have been paid and that the net proceeds of the Issue have been received as cash but does not reflect the application of funds as those additional expenditures will be made over time.



## PROFORMA CONSOLIDATED STATEMENT OF FINANCIAL POSITION AS AT 31 DECEMBER 2004

The table below sets out the proforma statement of financial position on the basis described in the preceding section.

	31/12/04 \$AUD'000	Adjustments for 60 Million Share Placement in February 2005 \$AUD'000	Adjustments for Implementation of Entitlement Offer \$AUD'000	Proforma Combined \$AUD'000
<b>CURRENT ASSETS</b>				
Cash assets	13,078	17,098	16,458	46,634
Receivables	1,123	-	-	1,123
<b>TOTAL CURRENT ASSETS</b>	<b>14,201</b>	<b>17,098</b>	<b>16,458</b>	<b>47,757</b>
<b>NON-CURRENT ASSETS</b>				
Cash Assets	70	-	-	70
Property, plant & equipment	21	-	-	21
Other financial assets	508	-	-	508
Exploration and evaluation expenditure	25,451	-	-	25,451
Production properties	4,896	-	-	4,896
<b>TOTAL NON-CURRENT ASSETS</b>	<b>30,946</b>	<b>-</b>	<b>-</b>	<b>30,946</b>
<b>TOTAL ASSETS</b>	<b>45,147</b>	<b>17,098</b>	<b>16,458</b>	<b>78,703</b>
<b>CURRENT LIABILITIES</b>				
Payables	984	-	-	984
Redetermination deferred income	264	-	-	264
Provisions	61	-	-	61
	1,309	-	-	1,309
<b>NON-CURRENT LIABILITIES</b>				
Provisions	88	-	-	88
<b>TOTAL NON-CURRENT LIABILITIES</b>	<b>88</b>	<b>-</b>	<b>-</b>	<b>88</b>
<b>TOTAL LIABILITIES</b>	<b>1,397</b>	<b>-</b>	<b>-</b>	<b>1,397</b>
<b>NET ASSETS</b>	<b>43,750</b>	<b>17,098</b>	<b>16,458</b>	<b>77,306</b>
<b>EQUITY</b>				
Contributed equity	85,680	17,098	16,458	119,236
Reserves	236	-	-	236
Accumulated losses	(42,166)	-	-	(42,166)
<b>TOTAL EQUITY</b>	<b>43,750</b>	<b>17,098</b>	<b>16,458</b>	<b>77,306</b>

### Notes

**60 million share placement.** This adjustment has been calculated on the basis of proceeds received of AUD\$18M less costs of the offer of AUD\$0.902M.

**Implementation of the Entitlement Offer.** The adjustment has been calculated assuming the successful implementation of the Entitlement Offer resulting in proceeds of AUD\$17.418M, offset by AUD\$0.96M estimated costs of the Entitlement Offer.

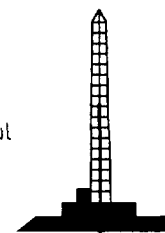

## GLOSSARY

---

The following definitions are used in this Prospectus, and unless the context otherwise requires they have the following meanings:

- **"AUD"** means Australian dollars.
- **"ASIC"** means the Australian Securities and Investment Commission.
- **"ASX"** means the Australian Stock Exchange.
- **"Chess"** means clearing house electronic sub-register system.
- **"Closing Date"** means 27 June 2005.
- **"Constitution"** means Cue Energy Resources' constitution.
- **"Cue Energy Resources"** or **"Cue"** or **"the Company"** means Cue Energy Resources Limited.
- **"Cue Energy Resources Group"** means Cue Energy Resources and its Subsidiaries.
- **"Directors"** means the directors of Cue Energy Resources Limited.
- **"Eligible Shareholders"** means a holder of Ordinary Shares registered at 5.00pm on the Record Date with a registered address in Australia, New Zealand, Papua New Guinea or Singapore.
- **"Entitlement and Acceptance Form"** means the entitlement and acceptance form accompanying this Prospectus.
- **"Existing Shares"** means the existing Ordinary Shares of the class on issue at the Record Date.
- **"Gas Sale Agreement"** means the agreement entered into between Santos (Sampang) Pty Ltd, Singapore Petroleum Sampang Ltd and Cue Sampang Pty Ltd as sellers, and PT Indonesia Power, as buyer, dated 19 July 2003.
- **"Joint Venture"** means the Sampang PSC joint venture entered into between the Joint Venture Parties.
- **"Joint Venture Parties"** means Santos (Sampang) Pty Limited, Singapore Petroleum Sampang Ltd and Cue Sampang Pty Limited.
- **"New Shares"** means the Ordinary Shares offered pursuant to this Prospectus.
- **"Offer"** means Cue Energy Resources Limited's offer of Rights and New Shares as contained in this Prospectus.
- **"Ordinary Shares"** means ordinary shares in the capital of Cue Energy Resources.
- **"POMSOX"** means the Port Moresby Stock Exchange.
- **"Record Date"** means 30 May 2005.
- **"Registrar"** means Computershare Investor Services Pty Limited in Victoria, Australia.
- **"Rights"** means the entitlement to subscribe for New Shares under the Offer.
- **"Sampang PSC"** means the Sampang production sharing contract entered into by Santos (Sampang) Pty Ltd, Cue Sampang Pty Ltd and Singapore Petroleum Sampang Ltd.
- **"scf/d"** means standard cubic feet per day.
- **"Security Renunciation Form"** means the security renunciation form accompanying this Prospectus.
- **"Shareholders"** means the holders of Ordinary Shares.
- **"Subsidiaries"** means, as at the date of this Prospectus, Galveston Mining Corporation Pty Ltd, Cue PNG Oil Pty Ltd, Cue Exploration Pty Ltd, Cue Energy Holdings Ltd, Cue Energy Indonesia Pty Ltd, Tanjung Jabung Pty Ltd, Cue Sampang Pty Ltd, Highlands Oil and Gas Pty Ltd, Toro Oil Pty Ltd and Omati Oil Pty Ltd.

All references to statutes or regulations are to statutes or regulations of Australia, unless otherwise specified in this Prospectus. All references to the time of the day are to Australian Eastern Standard time.



## APPENDIX A

### Continuous Disclosure Notices to ASX

10/05/2005	To make Renounceable Pro-rata Entitlement Offer	31/01/2005	Suspension from Official Quotation
06/05/2005	Delisting from NZ Stock Exchange	28/01/2005	Investor Presentation - January 2005
03/05/2005	Change of Director's Interest Notice x4	27/01/2005	Trading Halt
03/05/2005	Oyong Platform Installation Begins	24/01/2005	Corr: Second Quarter Activities & Cash Flow Reports
02/05/2005	Disclosure of Directors and Officers Relevant Interests	24/01/2005	First Quarter Activities & Cashflow Reports
02/05/2005	Appendix 3B - Exercise & Issue of Options	21/01/2005	Jeruk -2 Well Results
29/04/2005	SE Gobe 11 Extends Field	20/01/2005	Buys 5% Interest in Maari Oil Field NZ
29/04/2005	Reinstates in Jeruk Oil Discovery	17/01/2005	PNG Seismic Survey Begins
27/04/2005	Third Quarter Activities & Cashflow Reports	12/01/2005	Change in substantial holding
14/04/2005	Oyong Oil & Gas Field Development Approval	12/01/2005	Appendix 3B
11/04/2005	Jeruk 3D Seismic Survey Begins	22/12/2004	Placement Finalized
18/03/2005	Maari Oil Field Purchase Finalised	15/12/2004	Placement & Progress Report
07/03/2005	SE Gobe - 11 Begins Drilling	15/12/2004	Appendix 3B
28/02/2005	Half Yearly Report & Half Year Accounts	15/12/2004	Trading Halt
14/02/2005	Proposed Petrochemical Plant - Port Moresby New Guinea	07/12/2004	Accepts New Australian Exploration Permits
11/02/2005	Becoming a substantial holder	29/11/2004	Offered New Australian Exploration Permits
10/02/2005	Now Incorporated in Australia	26/11/2004	Results of Meeting & Chairman's Address
10/02/2005	Recent Placements - Corporations Act Disclosure	19/11/2004	Amended Disclosure of Director's Relevant Interests
09/02/2005	Appendix 3B - Acq/Project Devts/ Working Capital	18/11/2004	Appendix 3B - In satisfaction of options exercised
08/02/2005	Change of Director's Interest Notice x4	18/11/2004	Disclosure of Directors & Officers Relevant Interest
08/02/2005	Cue Awarded New Australian Exploration Permits	12/11/2004	Issue of Securities Unlisted Options
04/02/2005	Sale & Purchase Agreement for Maari Field Purchase	08/11/2004	Grant of Unlisted Options
01/02/2005	Placement of 60m shares to raise \$18m	04/11/2004	Disclosure of subsequent director relevant interest
01/02/2005	Reinstatement to Official Quotation	01/11/2004	Notice of Annual General Meeting
31/01/2005	Share Placement	25/10/2004	Jeruk Oil Discovery
		19/10/2004	First Quarter Activities & Cash Flow Reports
		29/09/2004	Early Oil Development Planned for Oyong

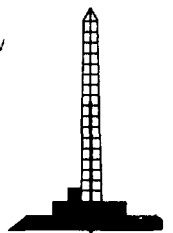

This page has been left blank intentionally

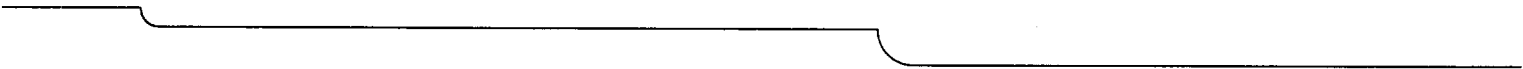
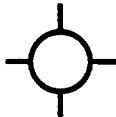



ERROR: timeout  
OFFENDING COMMAND: timeout

STACK:

-savelevel-



Cue Energy Resources Limited

ABN 45 066 383 971

## PROSPECTUS

# 2009

### CONFIDENTIAL

FOR A RENOUNCEABLE PRO-RATA ENTITLEMENT OFFER OF ONE NEW SHARE FOR EVERY FIVE EXISTING SHARES AT AN ISSUE PRICE OF AUD20 CENTS.

#### **This Prospectus is important**

Shareholders should be aware that their entitlements may have value and should deal with them rather than allow them to lapse. If you are in any doubt about how to deal with your entitlement, please contact your stock broker, financial adviser, solicitor, accountant or other professional adviser immediately.

The Issue is Fully Underwritten.

The securities offered under this Prospectus are of a speculative nature.

# CORPORATE DIRECTORY

## DIRECTORS

R.G. Tweedie LL.B - Chairman  
E.G. Albers LL.B  
K. Hoolihan MSc(Hons)  
L. Musca LL.B

## REGISTERED OFFICE

### AUSTRALIA

25th Floor, 500 Collins Street  
Melbourne Victoria 3000  
Telephone: 61 3 9629 7577  
Facsimile: 61 3 9629 7318  
E-mail: mail@cuenrg.com.au

## STOCK EXCHANGE LISTINGS

### Australia

Australian Stock Exchange (ASX)  
Level 3, 530 Collins Street  
Melbourne Victoria 3000 Australia  
ASX Code: CUE  
Telephone: 61 3 9617 8611

### Papua New Guinea

Port Moresby Stock Exchange (POMSoX)  
Level 4, Defens Haus  
Cnr of Champion Parade and Hunter Street  
PO Box 1531, Port Moresby, NCD  
Papua New Guinea  
POMSoX Code: CUE  
Telephone: 675 320 1980  
Facsimile: 675 320 1981

## AUDITOR

PKF  
Level 11, CGU Tower, 485 La Trobe Street  
Melbourne Victoria 3000 Australia

## SHARE REGISTRY

### Australia

Computershare Investor Services Pty Limited  
Yarra Falls  
452 Johnston Street  
Abbotsford VIC 3067 Australia  
General enquiries: 1300 850 505  
Overseas holders: +61 3 9415 4000  
Facsimile: 61 3 9473 2500  
Website: www.computershare.com  
Email: web.queries@computershare.com.au

## Papua New Guinea

Deloitte Touche Tohmatsu  
Level 12, Deloitte Tower  
Douglas Street  
PO Box 1275  
Port Moresby, NCD  
Papua New Guinea  
Telephone: 675 321 1888  
Facsimile: 675 321 1986

## IMPORTANT DATES

EVENT	PROPOSED DATE
	<i>(Estimate only)</i>
Rights Trading Opens and Shares Trade ("ex Rights")	24 May 2005
Record Date	30 May 2005
Offer Opens	6 June 2005
Stock Exchange Rights Trading Ceases	20 June 2005
Offer Closes	27 June 2005
Allotment of Shares	30 June 2005
Expected date of issue of Shareholder Statements	4 July 2005

## FORWARD LOOKING STATEMENTS

Various statements in this Prospectus constitute statements relating to intentions, future acts and events. Such statements are generally classified as forward looking statements and involve known and unknown risk, uncertainties and other important factors that could cause those future acts, events and circumstances to differ from the way or manner in which they are expressly or impliedly portrayed herein.

**No securities will be issued or allotted on the basis of this prospectus later than 13 months after the date of this prospectus.**

This Prospectus is dated 19 May 2005. A copy of this Prospectus has been lodged with the Australian Securities and Investments Commission on 19 May 2005. The Australian Securities and Investments Commission take no responsibility for the contents of this Prospectus.



## CONTENTS

2	CHAIRMAN'S LETTER
4	SUMMARY OF OFFER
8	IMPORTANT DATES
14	MAIN TERMS OF THE OFFER
28	CAPITAL STRUCTURE AND EFFECT OF THE ISSUE ON THE COMPANY
30	GLOSSARY

## IMPORTANT NOTICE



This Prospectus is dated 19 May 2005 and contains an offer to Eligible Shareholders in Cue Energy Resources Limited ("Cue Energy Resources") to subscribe for New Shares in Cue Energy Resources.

A copy of this Prospectus was lodged with the Australian Securities and Investment Commission ("ASIC") on 19 May 2005

ASIC, the Australian Stock Exchange Limited ("ASX") and Port Moresby Stock Exchange Limited ("POMSOX") take no responsibility for the contents of this Prospectus.

If you are in any doubt as to how to deal with this Prospectus, please consult a member of ASX or POMSOX or your financial or legal adviser immediately.



Receipt of this Prospectus and/or Letter of Entitlement and Acceptance Form will not constitute an offer of, or an invitation to subscribe for, any of the New Shares in those jurisdictions in which it would be unlawful to make such an offer or invitation. Cue Energy Resources prohibits the sending of this Prospectus and Letter of Entitlement and Acceptance Form into any such jurisdictions and reserves the right to refuse to issue any New Shares if it believes to do so would violate the applicable legal or regulatory requirements.

In this Prospectus:

1. Definitions of capitalised terms used are contained in the glossary on page 30.
2. A reference to time, unless the contrary is stated, is a reference to Australian Eastern Standard Time.

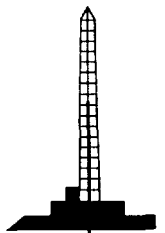

## LETTER TO SHAREHOLDERS



May 2005

Dear Shareholder,

### **Cue Energy Resources Limited Entitlement Offer**

As you are aware, Cue Energy Resources Limited ("Cue") has reinstated its rights in the Jeruk oil discovery in the Sampang Production Sharing Contract (PSC) area, offshore East Java, Indonesia. By doing so, Cue has regained its full 15% interest in what could be a significant oil discovery. Cue is now required to pay a lump sum of approximately AUD\$11 million which is equivalent to the costs it would have incurred in the Jeruk -1 and Jeruk -2 wells and, in addition, will be required to pay a premium based on these costs, but only out of future Jeruk production (see also page 19).

In May 2005, it is proposed to re-enter the Jeruk -2 well, and to sidetrack, core and test the well. The rights issue will fund this activity and the lump sum payment. An additional four appraisal wells are proposed to be drilled beginning in the fourth quarter 2005. Cue will be required to also fund its 15% share of this activity. A further equity raising will be required to fund this drilling programme.

Cue has other ongoing activities. It is also participating in a joint venture development of the Oyong oil and gas field in the Sampang PSC area, offshore East Java, Indonesia. Exploration drilling is expected to continue in the PSC in an effort to find additional hydrocarbon discoveries that may compliment the Oyong development.

Significant progress has been achieved by the operator, Santos, towards the development of Oyong. The well head platform has been installed and development drilling is beginning, with oil production expected to begin by year end 2005, and gas production beginning around year end 2006.

In Papua New Guinea, oil production continues from the SE Gobe field, in which Cue Energy Resources has a participating interest, at a total field rate of approximately 6500 barrels of oil per day (Cue share approximately 250 barrels of oil per day). The recent SE Gobe 11 development well is projected to add around 2000 barrels of oil per day to the field rate. A study has also been made in an effort to commercialise some of Cue Energy Resources' share of discovered gas resources.

In March 2005, Cue completed the purchase of a 5% interest in the Maari oil field, in the offshore Taranaki Basin of New Zealand. The purchase price was AUD\$6.2 million. We expect that a Maari development decision will be made later in 2005, with first oil production expected in mid 2007.

Following shareholder mandate at the last General Meeting, in December 2004 and February 2005, Cue made placements of a total of 100 million shares to raise a total of AUD\$28 million (before fees) for Oyong oil development costs and for Maari purchase and development costs. These placements did not raise funds specifically for Jeruk.

While Cue can use existing cash funds to pay the Jeruk lump sum and Jeruk -2 re-entry appraisal costs in the short term, these funds will need to be replaced to cover Oyong and Maari costs for which those funds had been allocated.

At the annual General Meeting of shareholders of Cue Energy Resources on 26 November 2004, shareholders also indicated to the board of directors ("the Board") that they would like to have the opportunity to take up further shares by way of entitlement issues, should Cue Energy Resources require further capital.

The Board therefore has resolved to offer Cue Energy Resources' shareholders a one for five renounceable pro rata entitlement offer of new Ordinary Shares at AUD20 cents ("New Share"). This means that for every five Ordinary Shares you hold you will have the right to subscribe for one New Share or to sell your Rights to take up that New Share.

The Offer will raise approximately AUD\$17.4 million from the issue of New Shares. The offer is fully underwritten by Todd Petroleum Mining Company Limited (a company associated with me and another Cue director Mr. K. Hoolihan) and Great Missenden Holdings Pty Ltd. (a company associated with Cue director, Mr E.G. Albers).

I encourage you to take up your entitlement to support the Company's projects.

Yours sincerely



**Richard Tweedie**  
*Chairman*

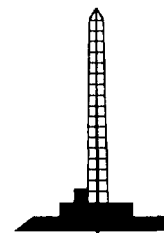
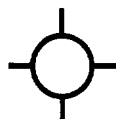

## SUMMARY OF THE OFFER

### THE ISSUER

Cue Energy Resources is the issuer of the Rights and New Shares offered under this Prospectus. Cue Energy Resources is a company registered under the Corporations Act 2001 having its registered office at Level 25, 500 Collins Street, Melbourne, Australia.

### THE OFFER

This Prospectus offers all Eligible Shareholders who are on the register of Cue Energy Resources as at 5.00 pm on the Record Date (30 May 2005), the opportunity to subscribe for one Cue Energy Resources Ordinary Share ("New Share") for every five Existing Shares currently held.

### SUBSCRIPTION PRICE AND ENTITLEMENT

The subscription price for the New Shares is AUD20 cents each, to be paid in Australian currency. Each Eligible Shareholder's entitlement (also referred to as Rights) is recorded on the Letter of Entitlement and Acceptance Form accompanying this Prospectus. Fractional entitlements to New Shares will be disregarded.

### PURPOSE

The issue of New Shares will raise approximately AUD\$17.4 million in new capital for Cue Energy Resources, which will enable it to replace funds expended on buying back into and, to assist in, appraising the Jeruk field.

### UNDERWRITING

The Offer is fully underwritten by Todd Petroleum Mining Company Limited as to 80% and Great Missenden Holdings Pty Ltd as to 20%.

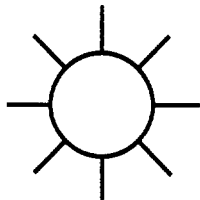
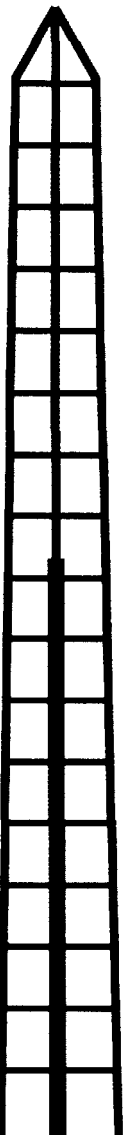

## QUOTATION

Applications will be made by Cue Energy Resources for the Rights and New Shares to be quoted on the ASX and POMSIX within 7 days after the date of this Prospectus. ASX and POMSIX accept no responsibility for any statement in this Prospectus.

## ACTION TO BE TAKEN BY SHAREHOLDERS

You may take one of the following actions:

- A) accept** your entitlement in full; or
- B) sell part** of your entitlement (Rights) and accept the balance; or
- C) sell** your entitlement (Rights) in full; or
- D) do nothing** and forfeit your entitlement.

### Important Notice

If you take no action by 5.00pm on 27 June 2005 your entitlement to subscribe for New Shares will be forfeited, you will not receive any potential value residing in your Rights and your shareholding may be diluted. Similarly, if you accept less than your full entitlement and you do not sell the balance of your Rights to subscribe for New Shares, you will not receive any value residing in the entitlement not accepted or sold and your shareholding may be diluted. Therefore it is important that you take action either to accept your entitlement or sell your Rights. Set out below are instructions on how to take each of the alternate actions set out above.

#### A. Acceptance in full

To accept your entitlement in full:

- (a) complete the enclosed Entitlement and Acceptance Form in accordance with the instructions on that form;
- (b) attach your cheque or bank draft (denominated in Australian dollars) made payable to "Cue Energy Resources Limited" for the amount required to be paid in accordance with the payment instructions set out below; and

- (c) forward your completed Entitlement and Acceptance Form and your cheque or bank draft to:

#### Postal:

Cue Energy Resources Limited  
c/- Computershare Investor Services Pty Limited  
GPO Box 52  
Melbourne Vic 8060 Australia

#### Hand Delivery:

Cue Energy Resources Limited  
c/- Computershare Investor Services Pty Limited  
Yarra Falls  
452 Johnston Street  
Abbotsford Vic 3067 Australia

or to any member of the ASX or POMSIX so as to be received by the Registrar no later than 5.00pm on 27 June, 2005.

OR

#### B. Sale of part of entitlement (Rights) and acceptance of the balance

To sell part of your entitlement (Rights) and accept the balance:

- (a) instruct a member of ASX or POMSIX to sell the number of Rights which you wish to renounce. Rights may only be traded in the period between 24 May 2005 and 20 June 2005 on the ASX and POMSIX.
- (b) complete and sign the Security Renunciation Form, ensuring you have included the "Entitlement No." shown on your Entitlement and Acceptance Form;
- (c) complete the enclosed Entitlement and Acceptance Form for the number of New Shares you wish to accept in accordance with the instructions on that form;
- (d) attach your cheque or bank draft (denominated in Australian dollars) made payable to "Cue Energy Resources Limited" and crossed "Not Negotiable" for the amount required to be paid in accordance with the payment instructions set out below; and

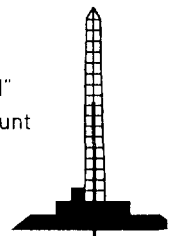

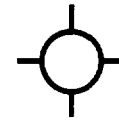

- (e) forward both the completed Security Renunciation Form and your completed Entitlement and Acceptance Form together with your cheque or bank draft to, the member of the ASX or POMSOX whom you instructed to sell the Rights.

If you wish to sell some of your Rights, you must do so before Rights trading ceases.

**OR**

**C. Sale of entitlement in full**

To sell your entitlement (Rights) in full:

- (a) instruct a member of ASX or POMSOX to sell your Rights. Rights may only be traded in the period between 24 May 2005 and 20 June 2005 on ASX and POMSOX;
- (b) complete and sign the Security Renunciation Form, ensuring you have included the "Entitlement No." shown on your Entitlement and Acceptance Form; and send your Entitlement and Acceptance Form, including the completed Security Renunciation Form, promptly to the member of ASX or POMSOX you instructed.

If you wish to sell your entitlement, you must do so before Rights trading ceases.

**OR**

**D. Do nothing**

If you take no action by 5.00pm on 27 June, 2005 your Rights will be forfeited, you will not receive any value residing in your Rights and your shareholding may be diluted. Similarly, if you accept less than your full entitlement and you do not sell the balance of your Rights to subscribe for New Shares, you will not receive any value residing in the Rights not accepted or sold and your shareholding may be diluted.

**PAYMENT INSTRUCTIONS**

The New Shares are payable in full by payment of AUD20 cents per New Share on acceptance.

Payment must be made in Australian dollars by cheque or bank draft, drawn on and payable at any Australian bank.

Cheques or bank drafts are to be made payable to "Cue Energy Resources Limited" and crossed "Not Negotiable".

If you need assistance you should contact a member of the ASX or POMSOX or your financial or legal adviser.

**UNDERWRITING ARRANGEMENTS AND POSSIBLE IMPLICATIONS**

The Issue is underwritten by Todd Petroleum Mining Company Limited (Todd), as to 80%, and Great Missenden Holdings Pty Ltd (Great Missenden) as to 20%. Todd is an associate of both Richard Tweedie, who is Managing Director of Todd, and of Kenneth Hoolihan, Exploration Manager of Todd, both directors of the Company. Todd owns 9.91% of the Ordinary Shares currently on issue in Cue Energy Resources. Great Missenden is controlled by Geoffrey Albers, a director and substantial shareholder of the Company. The terms of the underwriting provide that Todd and Great Missenden will receive commission of 5% of the total amount raised making a total payment of approximately \$871,000. Given that the New Shares will represent approximately 16.6% of the expanded share capital of Cue Energy Resources, should it eventuate that none of the members' entitlements to New Shares is taken up, then Todd would, through the underwriting, be required to subscribe for 80% of all of the New Shares which would result in it holding approximately 21% of the expanded share capital. Great Missenden is not presently a shareholder of the Company. In the event that none of the members' entitlements were taken up, then Great Missenden would through the underwriting, be required to subscribe for 20% of the New Shares, which would result in Great Missenden holding 3.3% of the expanded capital.



Mr. Albers relevant interest would on this basis, increase to 11.5%. A smaller shortfall would mean a smaller underwriting obligation and result in a correspondingly smaller increase in Todd's and Great Missenden's percentage holding of Ordinary Shares.

The underwriting agreement with Todd and Great Missenden is unconditional save for the requirement that the Prospectus be issued and lodged by the Company and that no stop order in relation thereto is made by the ASIC.

Todd is New Zealand's largest locally owned producer of oil and gas. It has a predominant focus in oil and gas production and exploration. It has significant interests in electricity generation and gas\lpg distribution and retail.

#### **TAXATION AND STAMP DUTY IMPLICATIONS**

Applicants should seek their own respective independent advice in relation to matters relating to the operation of taxation and stamp duty laws in their respective countries of domicile.

The Company is unable to give advice on taxation matters generally, as each applicants position will relate to their own specific circumstances and to the laws of the country of residence.

Applicants should satisfy themselves of possible taxation consequences of purchases and sales of securities by consulting their own professional tax advisors.

#### **TREATMENT OF OVERSEAS SHAREHOLDERS**

The Offer is being made to Eligible Shareholders only. Eligible Shareholders are holders of Ordinary Shares registered at 5.00pm on the Record Date with a registered address in Australia, New Zealand, Papua New Guinea or Singapore.

In accordance with the Listing Rules of the ASX, Cue Energy Resources has decided that it would be unreasonable to extend this offer to shareholders with registered addresses in countries other than Australia, New Zealand, Papua New Guinea and Singapore, having regard to:

- the number of shareholders resident in those countries;
- the number and value of New Shares that would be offered under the Offer to shareholders resident in those countries; and
- the cost of complying with the legal requirements, and the requirements of regulatory authorities, in those countries.

However, in accordance with the Listing Rules of the ASX, arrangements have been made for the entitlement (Rights) of shareholders registered addresses in countries other than Australia, New Zealand, Papua New Guinea and Singapore to be sold by a nominee for such shareholders (appointed by the Directors), provided there is a viable market in the Rights and a premium over the expenses of sale can be obtained.

Any sale by the nominee will be effected promptly after the Record Date. The ability to sell those Rights and the price obtained for those Rights are dependent on market conditions. The net proceeds of the sale, after deducting brokerage, will be sent to each of the shareholders for whose benefit the Rights have been sold, in proportion to their respective shareholding.

To the maximum extent permitted by law, Cue Energy Resources and the nominee will not be subject to any liability, including liability for negligence, for failure to sell Rights or to sell Rights at any particular price.

If there is not a viable market for those Rights or no value can be obtained for them, after deducting brokerage, they will be allowed to lapse.

Shareholders with registered addresses in Australia, New Zealand, Papua New Guinea and Singapore holding existing Ordinary Shares on behalf of persons who are resident overseas are responsible for ensuring that taking up their Rights does not breach the laws of the relevant overseas jurisdiction. The return of a duly completed Entitlement and Acceptance Form will constitute a representation by the applicant that there has been no breach of any such laws.

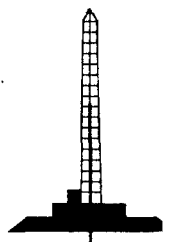

## IMPORTANT INFORMATION

### IMPORTANT DATES (estimate only)

Rights trading commences on the ASX and POMSIX and shares trade ("ex Rights")	24 May 2005
Record date for calculation of entitlements (5.00pm)	30 May 2005
Opening date	6 June 2005
Quotation and trading of Rights ceases on ASX and POMSIX	20 June 2005
Closing date and time for receipt of acceptances and Renunciations with payment of the issue price (5.00pm)	27 June 2005
Allotment of New Securities (no later than)	30 June 2005
Expected date of issue of Shareholder Statements	4 July 2005

### ANSWERS TO IMPORTANT QUESTIONS:

#### What sort of investment is this?

Shares are a means by which you can participate in the ownership of a company. By purchasing a share you become a part owner of the company. There are currently 435,443,755 fully paid Cue Energy Resources Ordinary Shares on issue. This offer is your opportunity to purchase more. Cue Energy Resources is offering holders of existing Shares, on a pro rata entitlement basis, one Ordinary Share for every five Ordinary Shares held, amounting in aggregate to a further 87,088,751 New Shares. This will result in 522,532,506 Ordinary Shares being on issue, post completion of the offer.

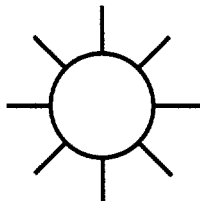
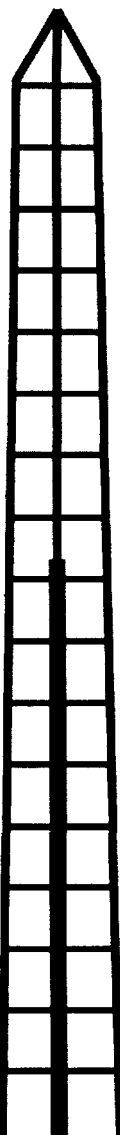



The New Shares are being offered on a renounceable pro rata entitlement basis. This means that Eligible Shareholders may accept their entitlements either in full or in part. An Eligible Shareholder who does not wish to accept their entitlement or wishes to accept it in part only may sell or transfer either in full or in part that portion of the entitlement (Rights) which the Eligible Shareholder does not wish to accept.

Applications will be made for the Rights to be quoted on ASX and POMSOX. Subject to approval of ASX and POMSOX, trading in Rights will commence on ASX and POMSOX on 24 May 2005.

New Shares will rank equally with other Ordinary Shares. Each New Share entitles the holder to:

- be present in person or by proxy, representative or attorney at a general meeting of Cue Energy Resources and have one vote on a poll for each fully paid Ordinary Share held on resolutions at a general meeting;
- an equal participation with other Ordinary Shares in any dividend declared by Cue Energy Resources;
- an equal participation with other Ordinary Shares in the residual assets on liquidation of Cue Energy Resources;
- be sent reports, notices of meetings and other information sent to Shareholders;
- transfer their Ordinary Shares by an instrument in writing in any usual form or in any other form that the directors approve, or by a proper transfer effected in accordance with the rules of the relevant stock exchange; and
- any other rights of a Shareholder conferred by the Constitution and the Corporations Act 2001.

Further details of the rights and obligations of Shareholders are set out in the Constitution.

### **Who is involved in providing it for me?**

The issuer of the Rights and of the New Shares is Cue Energy Resources Limited, Level 25, 500 Collins Street Melbourne Australia. Cue Energy Resources is listed on ASX and POMSOX.

The principal activities of the Company are set out on pages 15 to 24 of this Prospectus.

The company was incorporated in New Zealand in 1981 to explore for hydrocarbons. The company acquired its interest in the SE Gobe oil discovery in 1995, in the Sampang PSC (which contains the Oyong and Jeruk fields) in 1997 and in the Maari oil field in 2005. In early 2005, the Company transferred incorporation out of New Zealand and reincorporated in Australia.

### **How much do I pay?**

Each New Share is to be issued at AUD20 cents, to be paid in full and in Australian dollars on application.

There is no minimum investment amount and the Directors have not set a minimum level of subscriptions for the issue to proceed.

Application must be made on the Entitlement and Application Form accompanying this Prospectus and forwarded, with payment in full, to Cue Energy Resources Limited, C/- Computershare Investor Services Pty Limited at GPO Box 52, Melbourne, Victoria 8060, Australia, no later than 5.00pm on 27 June 2005, which is the Closing Date for the Offer. All cheques must be made payable to Cue Energy Resources Limited and crossed "Not Negotiable". The application instructions are set out in the Entitlement and Acceptance Forms accompanying this Prospectus.

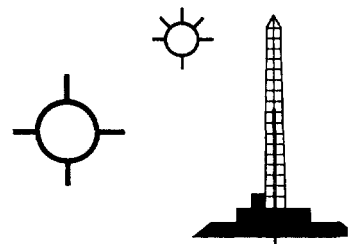

The New Shares will be allotted and CHESSE statements sent to subscribers as soon as practicable after the Offer closes but, in any event, allotment is expected to be completed not later than 30 June 2005.

#### **What are the charges?**

There are no charges to be paid by investors associated with this Offer. Cue Energy Resources will pay all costs in connection with the Offer including management fees, printing, posting, legal fees, share registry expenses and ASX and POMSOX fees. If you wish to sell any Rights to New Securities, you may be required to pay brokerage to the sharebroker who organises such sale for you (such charges are set by the sharebroker).

#### **What returns will I get?**

##### ***Rights***

Eligible Shareholders at the Record Date (30 May 2005 ) are offered the Rights at no cost. Applications will be made for the Rights to be quoted on ASX and POMSOX. Subject to approval of ASX and POMSOX, Rights trading on ASX and POMSOX will take place between 24 May 2005 and 20 June 2005.

Eligible Shareholders may take the following action with respect to Rights:

- Accept your entitlement in full; or
- Sell part of your entitlement (Rights) and accept the balance; or
- Sell your entitlement (Rights) in full; or
- Do nothing and forfeit your Rights.

The return (if any) from selling Rights will depend on the price at which those Rights can be sold on ASX or POMSOX assuming a listing of the Rights is granted on those exchanges. That price will in turn be influenced by the price at which Ordinary Shares are able to be sold on the relevant exchange. Some factors affecting the price of Ordinary Shares are described below.

None of Cue Energy Resources, the Directors, or any person associated with the Offer, guarantees or promises any return from the Rights. If you sell your Rights, the person legally liable to pay the return you will receive from the Rights is the person who buys them from you.

##### ***New Shares***

New Shares issued as a result of this Offer will rank equally, including as to dividends and voting, with the existing Ordinary Shares already on issue.

##### ***Dividends***

Shareholders' return on the New Shares will include any dividends declared by Cue Energy Resources after the issue of the New Shares. Dividends may be subject to tax.

Any dividends to be paid by Cue Energy Resources will be prudently set by the Directors having regard to factors affecting the Company's existing and future financial and operational performance taking into account factors such as general trading conditions, present and future competition and key input costs such as labour and general operating costs. If dividends are declared, Cue Energy Resources is legally liable to pay these.

##### ***Sale of New Ordinary Shares***

If a decision is made to sell the New Shares, a shareholder's returns will depend on a number of factors, many of which are not within the Company's control. If you sell your New Shares, the person legally liable to pay the returns you will receive from the New Shares is the person who buys them from you.



Some factors which may have an influence on the price of Cue Energy Resources' Ordinary Shares are:

- the results of exploration and the costs of exploration and development;
- material changes in oil and gas prices;
- material changes in the value of the Australian dollar against all currencies;
- the level of interest rates;
- the performance of the New Zealand, Australian, Papua New Guinea and Indonesian economies;
- disruption to Cue Energy Resources' oil and gas operations;
- acts of terrorism; and
- the occurrence of political or trade disputes in the regions where the Company operates.

None of Cue Energy Resources, the Directors or any person associated with the Offer guarantees the New Shares, or guarantees or promises that a dividend will be paid on the New Shares, or that the issue price will be recouped.

#### **What are my risks?**

No investment is risk free. The key to investment is understanding the nature of the risk and determining whether it is appropriate for you in meeting your investment needs. This Offer does not guarantee or promise you any return.

The principal risks for an investor are:

- not recovering in full the money paid for the New Shares and
- not receiving the returns discussed under the heading "What returns will I get?".

Various factors will affect these principal risks, including:

- expenditure on exploration and resulting success or lack of success;

- the effect of competition, market conditions, oil price and the depletion of oil reserves on the ongoing profitability of Cue Energy Resources' business;
- a lack of liquidity (i.e. buyers and sellers) in the market for Cue Energy Resources Ordinary Shares;
- market value of Cue Energy Resources' assets;
- a negative share market perception of Cue Energy Resources and/or the industry it is in;
- increased expenditure on the Oyong oil and gas development in the Sampang production sharing contract ("PSC") area. The Oyong oil and gas development is discussed further on page 19;
- mergers, joint ventures or acquisitions made by Cue Energy Resources which may adversely impact on the position/perception of Cue Energy Resources in the share market;
- changes to government policy, taxation or regulation in Australia, New Zealand, Papua New Guinea and Indonesia, particularly in relation to oil and gas exploration and production;
- the Indonesian authorities not giving the requisite approvals in respect of the development of Oyong by Cue Energy Resources and the other Joint Venture Parties. This is discussed in more detail on page 24;
- the Jeruk appraisal programme not being successful or being less successful than anticipated;
- the continuing solvency of Cue Energy Resources; and
- blowouts, fires and other disasters in hydrocarbon exploration and production in which Cue Energy Resources is participating.

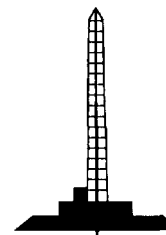

Additional special trade factors that could materially affect the prospects of the Cue Energy Resources Group are set out on page 24.

There is no risk of a subscriber being required to pay more money for the New Shares other than that disclosed above.

It is reasonably foreseeable that if:

- Cue Energy Resources is liquidated and there is insufficient money to repay your original subscription moneys,

you will receive less than the amount paid to Cue Energy Resources under this Offer.

#### ***Consequences of Insolvency***

In the event that Cue Energy Resources is put into liquidation or is wound up, all claims of creditors of Cue Energy Resources (such as fees and expenses of any liquidator, wages and salaries of employees, taxes, any moneys owing to any mortgagee or other chargeholder over Cue Energy Resources assets or any trade creditors), will rank ahead of claims by ordinary Shareholders.

After all other creditors have been paid, Ordinary Shareholder claims will rank equally.

In the event of Cue Energy Resources becoming insolvent, you will have no liability to pay any additional money to any person. An exception to this may occur where a dividend has been paid by Cue Energy Resources at a time when Cue Energy Resources did not satisfy the solvency test set out in the Corporations Act 2001. In that case a liquidator may call for the return of the money which made up this dividend.

**This is not an exhaustive list of risks, as many risks may not be foreseeable. You are advised to seek independent advice and consider your own position carefully before you invest.**

#### **Can the investment be altered?**

The rights associated with the New Shares, which are set out under the heading "What sort of investment is this", can only be altered by a special resolution of all Shareholders of Cue Energy Resources in accordance with its Constitution. A special resolution is a resolution approved by a majority of 75% of the votes of those shareholders entitled to vote and voting on the resolution. In limited circumstances, rights can be altered by a Court order.

#### **How do I sell my investment?**

You can sell your New Shares at any time after your New Shares have been issued to you.

If quotation is granted, Rights trading on ASX and POMSOX commences on 24 May 2005 and ceases on 20 June 2005. Should you subsequently wish to sell your New Shares you need to contact any member of ASX or POMSOX who will supply you with a securities transfer form (if necessary).

No charges are payable to Cue Energy Resources in respect of any sale of New Shares and Rights granted, although sales through a broker may incur brokerage fees. Investors can also sell their New Shares and Rights by private treaty.

As the Rights issued are new classes of security, the Directors of Cue Energy Resources are of the opinion that there is no established market for those securities. However the Directors expect that a market for the Rights will develop on ASX and POMSOX assuming that those securities are listed.

In respect of the New Shares the Directors of Cue Energy Resources are of the opinion that there is an established market on ASX and POMSOX.

**Who do I contact with enquiries about my investment?**

Enquiries about the Rights and the New Shares can be made to:

The Issuer:  
Company Secretary  
Cue Energy Resources Limited  
Level 25, 500 Collins Street  
Melbourne VIC 3000 Australia  
Phone +61 3 9629 7577  
Fax +61 3 9629 7318

Enquiries concerning the details that may be entered on the Share Register should be directed to:

Computershare Investor Services Pty Limited  
Yarra Falls, 452 Johnson Street  
Abbotsford 3067  
General Enquiries 1300 136 219  
Overseas Holders +613 9 415 4262  
Fax +613 9 743 2529

**Is there anyone to whom I can complain if I have problems with the investment?**

Complaints about the Rights and the New Shares can be made to:

Company Secretary  
Cue Energy Resources Limited  
Level 25, 500 Collins Street  
Melbourne VIC 3000 Australia  
Phone +61 3 9629 7577  
Fax +61 3 9629 7318

There is no ombudsman to whom you can complain in relation to the Rights or the New Shares being offered.



**What other information can I obtain about this investment?**

Further information about the Rights, New Shares and Cue Energy Resources are contained in this Prospectus and in Cue Energy Resources' financial statements. The most recent financial statements of Cue Energy Resources may be obtained free of charge by contacting the Company at Level 25, 500 Collins Street, Melbourne VIC 3000, Australia and are included on the Cue website [www.cuenrg.com.au](http://www.cuenrg.com.au).

This Prospectus, financial statements and other documents of, or relating to, Cue Energy Resources are filed on a public register at the Australian Securities and Investment Commission and are available for public inspection during normal working hours, on the payment of the prescribed fee.

**Annual Information**

In addition, as a Shareholder you will receive:

- a copy of the annual report; and
- statements relating to any distributions.

Cue Energy Resources is also required to make quarterly, half yearly and annual announcements to the ASX and POMSOX and other such announcements as are required by the continuous disclosure rules of those exchanges from time to time.

On request you can obtain information about your shareholding from Computershare Investor Services Pty Limited at GPO Box 52, Melbourne, Victoria 8060, Australia. No charge will be made for this information.

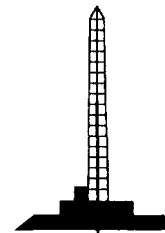

## MAIN TERMS OF THE OFFER

Cue Energy Resources Limited is the issuer of the Rights, New Shares offered under this Prospectus. Cue Energy Resources is an Australian company registered under the Corporations Act 2001 having its registered office at Level 25, 500 Collins Street, Melbourne Australia.

A description of the New Shares being offered is provided on page 10 of this Prospectus.

The New Shares are offered under this Prospectus at a price of AUD20 cents each.

It is intended that this Offer will raise approximately AUD\$17.4 million by the issue of New Shares to replace funds expended on buying back into, and to assist in, further appraisal of the Jeruk oil discovery in the Sampang PSC, Indonesia.

### FUNDING GENERALLY

Cue Energy Resources may require further funds for its programmes. Any such additional funds would be raised in a manner deemed the most expedient by the board of directors at the time, taking into account working capital, exploration results, budgets and sharemarket conditions.

Additional funds for exploration could be raised by any one or a combination of the following manners: placement of shares to excluded offerees, pro-rata issue to shareholders, the exercise of outstanding options, and/or a further issue of shares to the public. Should funds be required for development purposes the Company would, in addition, look to project loan finance.

### OPERATIONS AND PROJECTS

Cue Energy Resources is a company predominantly involved in production of, and exploration for, oil and gas. It currently holds participating interests in oil and gas ventures in Papua New Guinea, Indonesia, Australia and New Zealand. They are described further below.

Most of the developments in which the Company has interests are not mature and can be regarded, together with Cue Energy Resources Group's exploration prospects, as speculative.

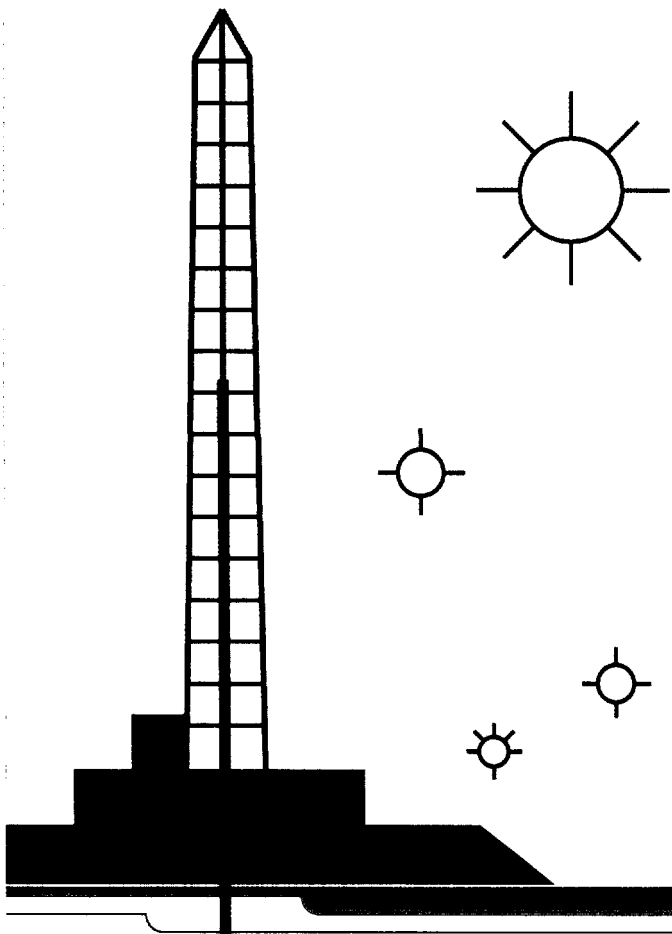

## PAPUA NEW GUINEA

In Papua New Guinea, Cue Energy Resources holds participating interests in the SE Gobe oil field and in three exploration areas (PPL 190, PRL-9 and PRL-8).

At the end of April 2005, the SE Gobe field was producing at a rate of approximately 6,500 barrels of oil per day, Cue Energy Resources share being approximately 250 barrels of oil per day. Over the final quarter of 2004, this share of field oil production resulted in production revenue to Cue of US\$1,026,971. The recent SE Gobe 11 development well will add an estimated 2000 barrels of oil per

day to field oil production. Oil production from the field is expected to continue at a declining level until around 2009.

Exploration drilling in 2003 in PPL190, where Cue Energy Resources holds a 10.947% interest, resulted in a small, currently sub commercial, oil discovery at Bilip -1. In late 2004 and early 2005, a 2D seismic survey was undertaken over the Wasuma trend, the Bilip area and the extension of SE Gobe structural trend to identify a drilling location for a late 2005 exploration well.

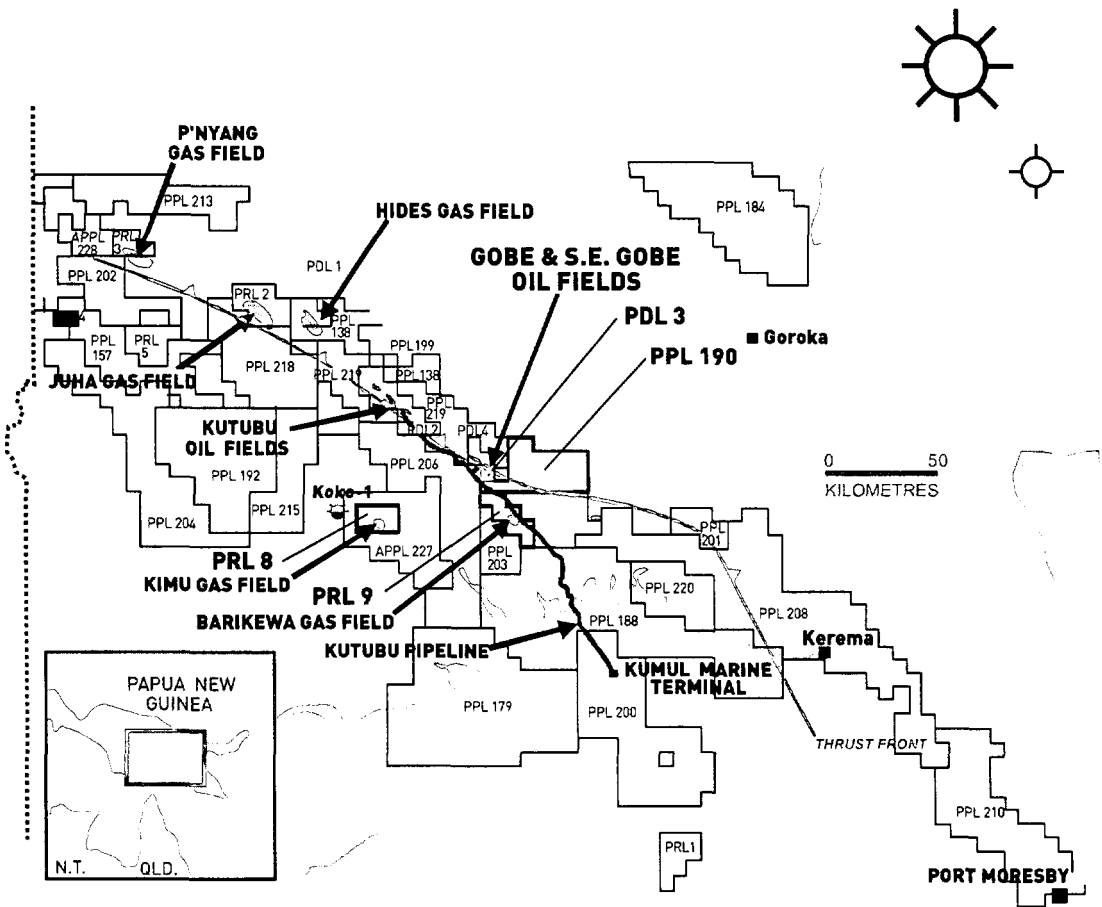

Figure 1. Papua New Guinea Location Map

In PRL -9, where Cue Energy Resources holds a 14.894% interest, the Barikewa gas field is estimated to contain approximately 800 billion cubic feet of recoverable natural gas (Cue Energy Resources share is approximately 120 billion cubic feet). In PRL -8, which contains the Kimu gas field which is estimated to contain approximately 1 trillion cubic feet of recoverable natural gas (Cue Energy Resources share is 110 billion cubic feet), studies have been undertaken to determine the potential to use gas from the field as feedstock for methanol production. Initiatives have been undertaken to export gas to Australia by pipeline; to export compressed natural gas to New Zealand, as well as use the gas as chemical feedstock.

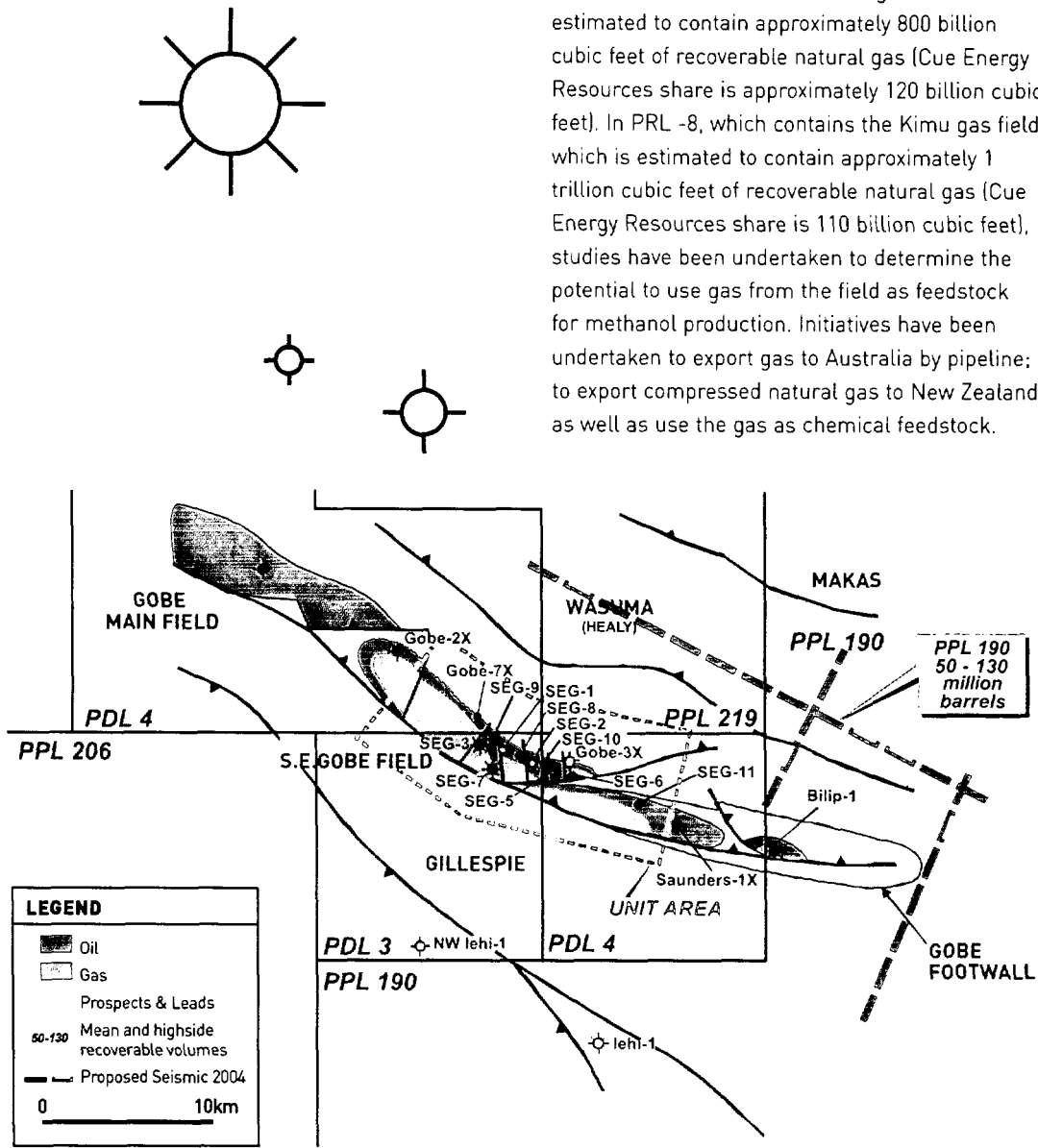

Figure 2. Papua New Guinea S.E. Gobe Area



## INDONESIA

In Indonesia, Cue Energy Resources holds a 15% participating interest in the Sampang PSC Joint Venture ("Joint Venture") which includes the Oyong gas and oil field development and the Jeruk oil discovery.

The Sampang PSC is operated by Santos (Sampang) Pty Ltd on behalf of the Joint Venture with participant equity interests as follows:

- Santos (Sampang) Pty Ltd 45%  
(Santos group - operator)
- Singapore Petroleum Sampang Ltd 40%
- Cue Sampang Pty Ltd 15%

*(A wholly owned subsidiary of Cue Energy Resources)*

Cue Energy Resources expects that additional exploration drilling will continue in the Sampang PSC area with one wildcat well (a speculative well) anticipated to be drilled in the second half of 2005.

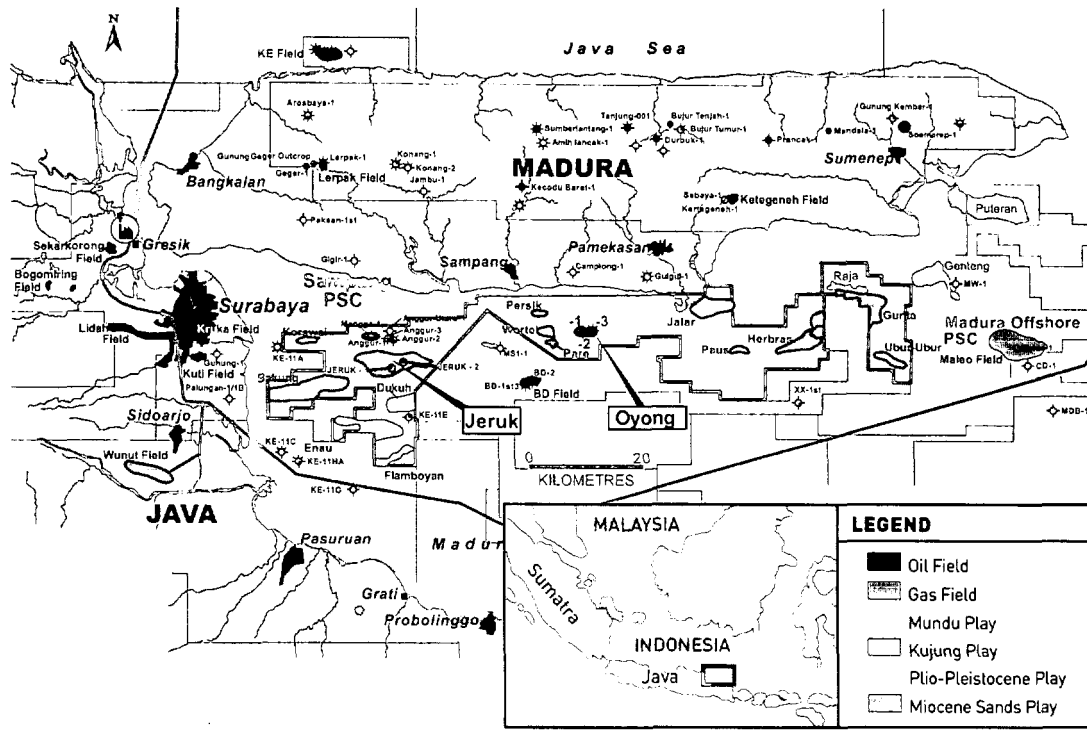

Figure 3. Current Sampang PSC Area Prospects and Leads Map

### Jeruk Oil Discovery

The Jeruk oil discovery is located in the Sampang PSC, offshore East Java, Indonesia, approximately 40 kilometres east of the city of Surabaya (fig 3) in approximately 40 metres water depth.

In April 2004, the Jeruk -1 well tested an oil and water emulsion (up to 80% water) from an open hole test at the top of the carbonate objective at a rate of 4700 barrels per day on a 3/8 inch choke.

The well was drilled on a sole risk basis by Santos. Cue declined to join the sole risk.

In July 2004, Santos began drilling the Jeruk -2 appraisal well approximately 1.6 kilometres east of Jeruk -1. Jeruk -2 was drilled on a sole risk basis by Santos. Cue, again, did not participate in the sole risk.

Jeruk -2 subsequently tested 7488 barrels of 33° API oil per day on a half inch choke over an 18 metre interval from 5134 to 5132 metres measured depth, at the top of the carbonate. The flow was constrained by the throughput capacity of the surface production test facilities.

The well was deepened to 5726 metres measured depth where an open hole test recovered 57 barrels of formation water from poor quality reservoir.

Due to mechanical difficulties, the well was then sidetracked to 5460 metres measured depth and an open hole test run over a 30 metre interval.

Oil, gas and water were recovered, but the flow potential could not be established due to debris in the test string. The qualities of the oil recovered and the pressure data from the test indicated that

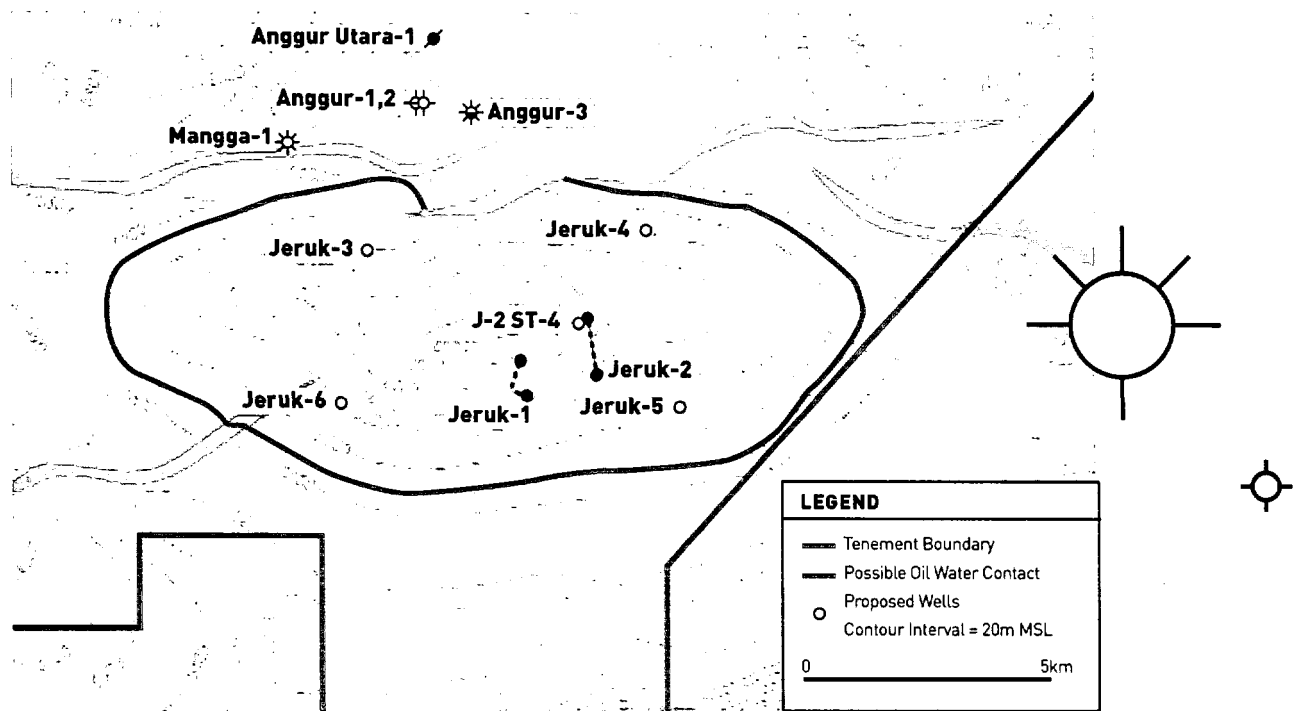

Figure 4. Jeruk Map



the oil is part of the same hydrocarbon column tested by the shallower Jeruk -2 test and that consequently, an oil column of at least 380 metres is likely to be present.

In a release to the ASX on 20 January 2005, the parent of the operator for the Sampang PSC, Santos Limited, advised that likely recoverable oil volumes could indicate an oil accumulation with potential to contain in excess of 170 million barrels of recoverable oil. Further appraisal drilling, integrated with the 3D seismic data which has been acquired and is now being processed, will be required to narrow the potential recoverable oil volumes of the field.

It is proposed to re-enter Jeruk -2 and to sidetrack, core and production test the well, beginning in late May 2005. A further four appraisal wells are planned for late 2005.

After carefully evaluating the results, Cue elected to reinstate its rights in the Jeruk discovery.

By reinstating its rights, Cue is obligated to pay in cash a lump sum amount of approximately US\$8.7 million (AUD\$11 million) which is equivalent to the cost it would have incurred if it had participated in the Jeruk -1 and 2 wells. The lump sum is required to be paid by 29 May 2005

In addition, Cue will be required to pay a premium, but sourced only out of future oil production from Jeruk. The premium is equivalent to ten times Cue's share of Jeruk -1 costs, plus five times Cue's share of Jeruk -2 costs. Cue estimates that this premium will approximate US\$55 million. Cue believes that the potential value of Cue's 15% interest in Jeruk will significantly exceed this premium, which, in any event, will only be paid out of oil production.

Cue has sufficient current cash to pay the lump sum and Jeruk -2 sidetrack, coring and testing costs. However, these funds are required to be replaced to cover anticipated ongoing Oyong and Maari development costs for which these funds had been originally allocated.

### Oyong Field

The Oyong gas and oil field is also located within the Sampang PSC area, offshore East Java and South of Madura Island (Fig 3).

### Oyong Background

The Oyong field was discovered in mid 2001 and has been delineated by a total of three wells. The oil and gas discovery is in 41 metres of water approximately 8 kilometres south of Madura Island and has a gas column of approximately 120 metres, underlain by a 38 metre oil column.

On July 19, 2003 a gas sales agreement was signed by the Joint Venture with PT Indonesia Power for the entire gas reserves of the Oyong field. The sale is denominated in US dollars. The gas is contracted to be supplied to the power station at Grati, East Java at a production rate of 40-60 million cubic feet of gas per day over a 7-10 year period.

It is estimated that reserves are:

### Million Barrels

	PROVEN (1P)	PROVEN + PROBABLE (2P)	PROVEN + PROBABLE + POSSIBLE (3P)
<b>Oil</b>			
Oil in Place	80	99	131
Recoverable	6.4	9.9	15.7

### Billion Cubic Feet

#### Gas (including solution gas)

Gas in place	143	169	183
Recoverable	107	135	147

The recoverable gas volumes do not allow for fuel and flare volumes.

Ongoing studies by the operator suggest that recoverable oil volumes are likely to be greater than the certified volumes.

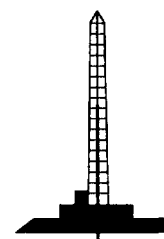

### Oyong Development

As a result of an increase in Oyong field recoverable oil estimates and high crude oil prices, the Joint Venture approved Oyong development plan has been modified to bring forward first oil production to fourth quarter 2005.

The new development will consist of a simple well head structure formed by triangular braced well conductors which will extend above the sea surface from a sea floor tall template structure. Seven oil and gas development wells are planned to be drilled through and between the conductors.

Oil and gas will be processed on a nearby moored barge. Oil will be exported by tanker and gas will be sent by pipeline to the P.T. Indonesia Power electricity generating station at Grati under the existing contract.

First gas is expected around end 2006. Solution gas associated with the early oil production will be reinjected until gas production begins to Grati.

Analysis of the Mundu Formation reservoir rock properties and consequent revised dynamic reservoir simulation modelling, has indicated that the initial oil production rate should reach 20,000 barrels of oil per day for a six horizontal oil wells development.

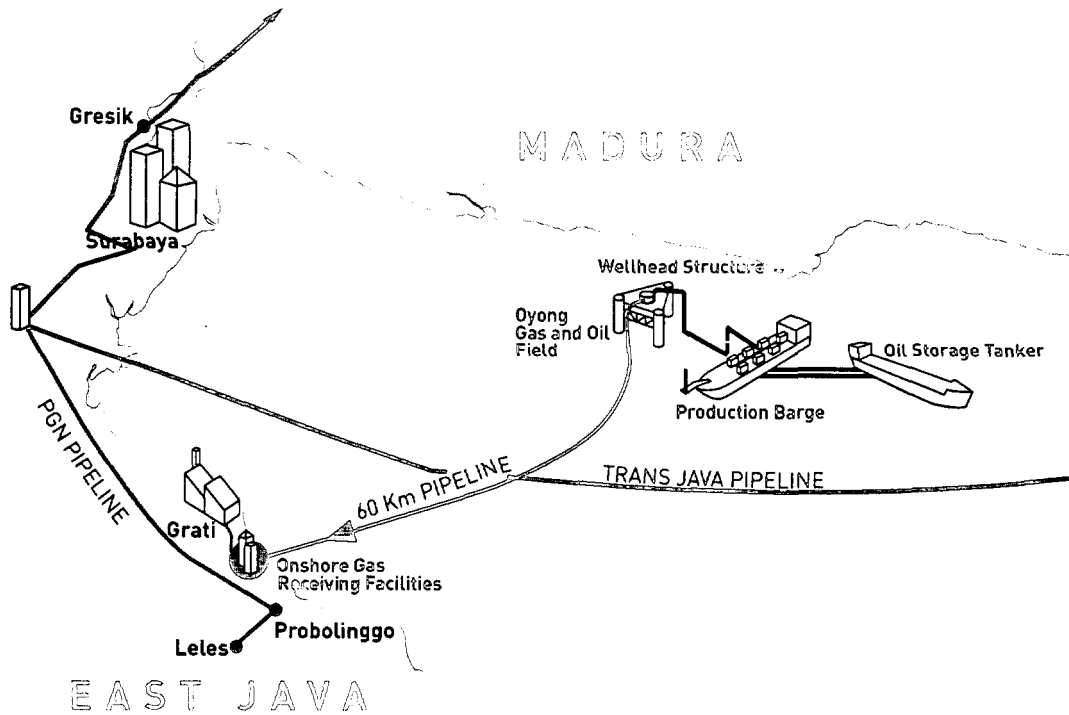

Figure 5. Oyong Development Concept



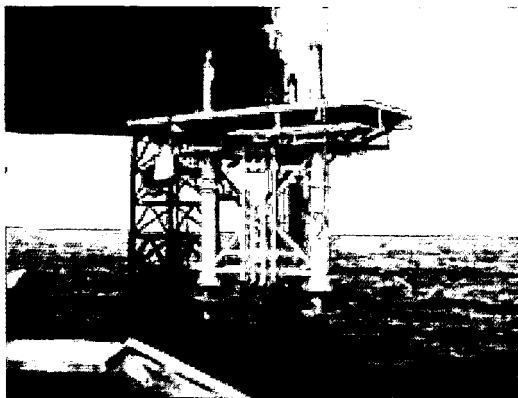
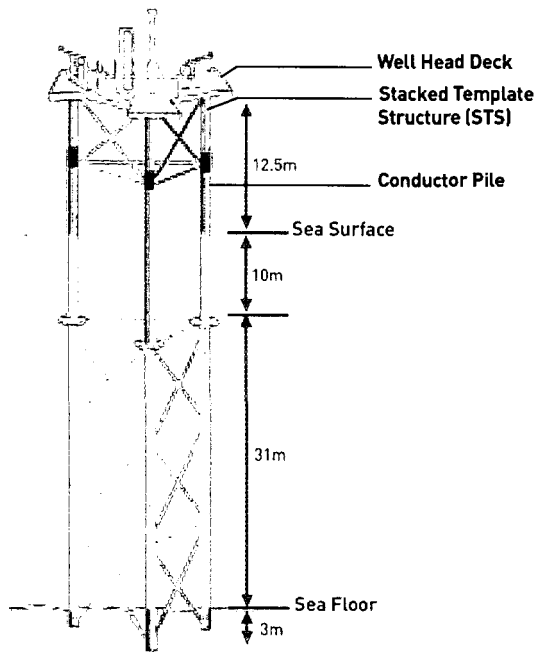
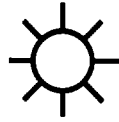

Figure 6. Well Head Platform

### Development Progress

In April 2005, the revised plan of development for the field was approved by the Indonesian authorities and field development formally began.

Approval of the environmental plan is expected shortly.

The well head platform was completed in mid April 2005 and installation, using the Ocean Sovereign jackup rig, began in the first week of May 2005. Development well drilling will follow platform installation and is expected to be completed around September 2005.

### Oyong Development Costs

Project development costs are expected to be US\$112 million. Cue Energy Resources' share would be US\$17 million (AUD\$22 million at AUD versus USD exchange rate of 0.78).

The requirement for securitization of gas sales payments has been reduced, as the increased oil revenue due to higher proven reserves and increased oil prices are expected to substantially cover the cost of development. Negotiations on securitizing gas payments under the Gas Sales Agreement are still continuing.

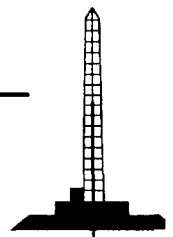
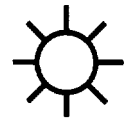

## NEW ZEALAND

In March 2005, Cue announced the purchase by Cue of Delta Oil Taranaki Pty Ltd's 5% interest in PEP 38413, the permit that contains the Maari oil field in the offshore Taranaki Basin, New Zealand.

Todd Petroleum Mining Company Limited, a company associated with Cue directors, Mr. R. Tweedie and Mr. K. Hoolihan, holds a 16% interest in the permit.

The purchase price was AUD\$6.2 million; which represents AUD\$2.48 per barrel for the 2.5 million barrels of P50 recoverable oil volumes for the Maari field attributable to Cue.

The Maari field, situated in 100 metres water depth, approximately 80km from the Taranaki coast, is the largest undeveloped offshore oil field in New Zealand. The field was discovered by the Moki -1 exploration well, drilled by Tricentrol (operator) and Cue Energy Resources in 1983 and

has been the subject of a number of subsequent delineation wells. Total P50 Moki formation recoverable oil volumes in the field are estimated to be approximately 50 million barrels.

### Maari Development

The possible development is likely to consist of a platform, with oil and associated gas being produced to a floating production oil storage vessel (FPSO), from which the oil will be exported by tanker.

It is expected that a development decision will be made later in 2005, with first oil production likely in mid 2007, at an initial production rate of around 30,000 barrels of oil per day (gross), with Cue's share being 1500 barrels of oil per day.

PEP 38413 also contains the smaller Manaia oil discovery, which may be developed in the future.

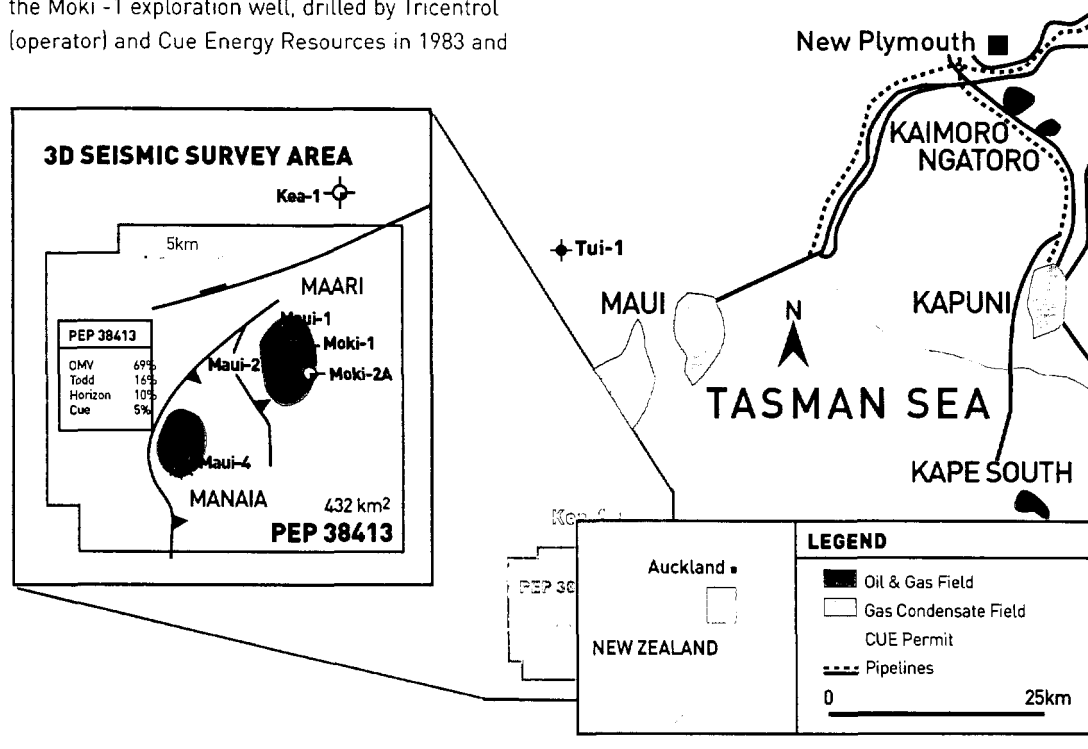

Figure 7. Maari Development

## AUSTRALIA

In late 2004 and early 2005, Cue Energy Resources was granted five offshore permits with two other parties associated with Mr. E.G. Albers, a director of Cue; two in the Bass Basin north of Tasmania and three in the Carnarvon Basin.

The two Bass Basin permits, T/37P and T/38P, are immediately adjacent to the Yolla/Gas condensate field which will begin production in mid 2005. T/38P contains the Pelican gas discovery which merits further study. Cue holds a 50% interest in each permit and will be the operator.

In the first two permit years, the existing technical data will be re-evaluated, ahead of planned 3D seismic surveys in the third year.

Two of the three Carnarvon Basin permits, WA360P and WA361P, are adjacent to the giant Rankin trend producing gas fields. The third permit, WA359P, is adjacent to the Exeter and Mutineer oil fields, which began oil production earlier in 2005. Cue holds a 50% interest in each permit and will be the operator. Despite their strategic location, the permits have only been lightly explored with wells.

In the first two years of each permit, the existing technical data will be re-evaluated to be followed by acquisition of new seismic data in permit year 3.

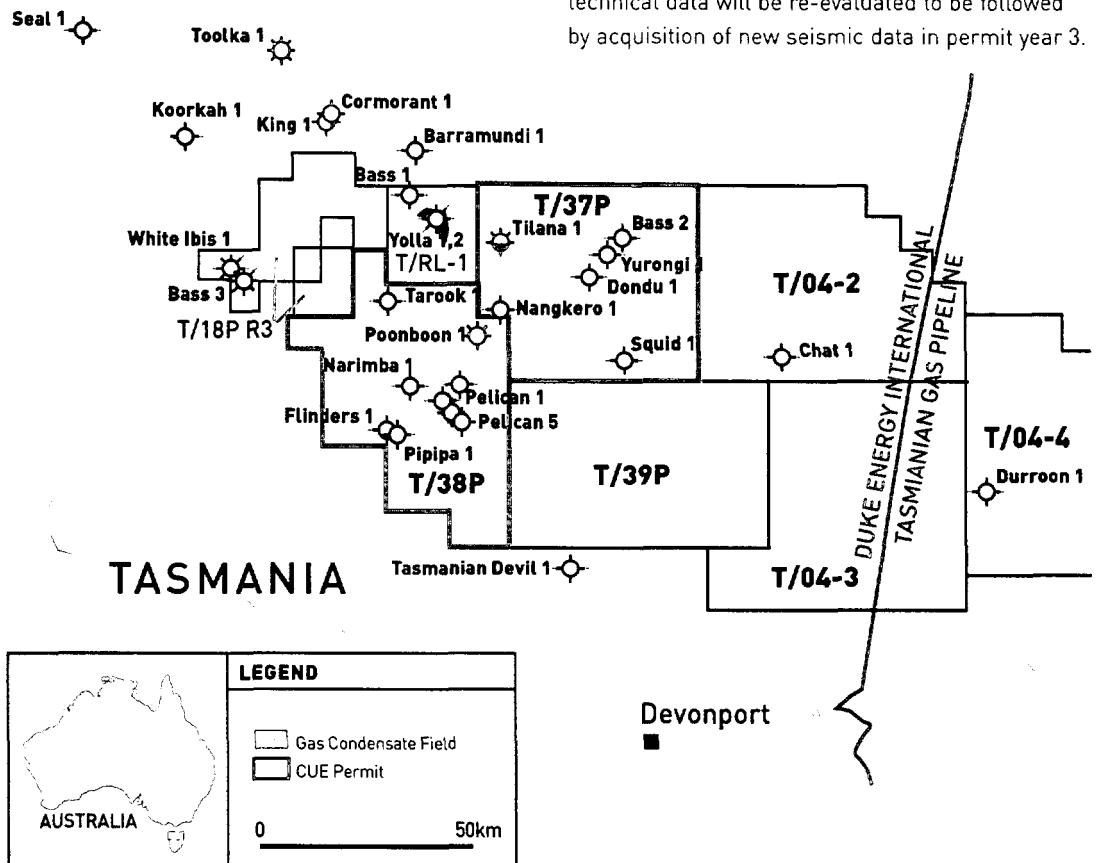







- The Maari development may prove to be less commercially positive than expected or development may be delayed.

Other risk factors associated with this Issue are detailed on page 11 of this Prospectus.

### **PRELIMINARY AND ISSUE EXPENSES**

The estimated amount of the issue expenses is AUD\$960,000. This will cover management fees, printing, postage, underwriting, legal fees, share registry expenses, ASX and POMSOX fees. No commission is payable in respect of this Offer.

### **OTHER TERMS OF OFFER AND SECURITIES**

All other terms of the Offer, and all terms of the Rights and New Shares being offered (except those implied by law and those contained in Cue Energy Resources' Constitution), are set out in this Prospectus.

### **AVAILABILITY OF FINANCIAL STATEMENTS**

The most recent independently reviewed financial statements of Cue Energy Resources were prepared as at 31 December 2004, and are contained in Cue Energy Resources' Half Yearly Report.

Copies of the Half Yearly Report and financial statements referred to in the preceding paragraph can be obtained free of charge on request by any person to whom this Offer is made, at the registered office of Cue Energy Resources at the offices of Level 25, 500 Collins Street Melbourne Australia and are posted on the Cue website [www.cuenrg.com.au](http://www.cuenrg.com.au).

### **ADDITIONAL INFORMATION**

Special content rules for this Prospectus Cue Energy Resources is a 'disclosing entity' for the purposes of the Corporations Act 2001 and, as such, is subject to regular reporting and disclosure requirements.

Normally a Prospectus for the issue of securities of a company must contain all the information that investors and their professional advisers

would reasonably require to make an informed assessment of each of the following:

- assets and liabilities, financial position and performance, profits and losses and prospects of the company that is to issue the securities; and
- the rights and liabilities attaching to the securities offered.

However, in reliance on section 713 of the Corporation Act 2001, this Prospectus does not comply with the general disclosure test. Under section 713 the disclosure test applicable to any company offering:

- shares in a class of shares that have been quoted on ASX at all times in the 12 months before the date of the Prospectus; or is a lower level of disclosure.

The lower level of disclosure, which applies to this Prospectus, is that the Prospectus must contain all the information investors and their professional advisers would reasonably require to make an informed assessment of:

- the effect of the offer on Cue Energy Resources; and
- the rights and liabilities attaching to the securities offered,

The Prospectus must contain this information only to the extent to which it is reasonable for investors and their professional advisors to expect to find the information in the Prospectus.

### **Copies of documents**

Copies of documents lodged at ASIC in relation to Cue Energy Resources may be obtained from, or inspected at, an office of ASIC.

ASX maintains detailed records of company announcements for all companies listed on the ASX. Copies of announcements made by Cue Energy Resources may be obtained from the ASX.

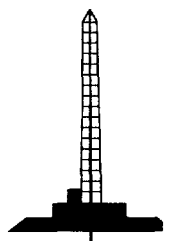

Cue Energy will provide a copy of the following documents, free of charge, to any person who asks for a copy during the application period for this Prospectus:

- the annual financial report of Cue Energy Resources for the year ended 30 June 2004, being the financial report most recently lodged with ASIC by Cue Energy Resources;
- the half-year financial report of Cue Energy Resources for the six months ended 31 December 2004;
- any continuous disclosure notices (that is, documents used to notify ASX of information relating to Cue Energy Resources) given by Cue Energy Resources after lodgement of the annual financial report for the year ended 30 June 2004 and before lodgement of this Prospectus with ASIC. Appendix A contains a list of such notices that are available; and
- the Constitution of Cue Energy Resources.

#### Interests of Directors

Other than as set out below or elsewhere in this Prospectus:

- no director has, or has had in the two years before lodgement of this Prospectus, an interest in the promotion of Cue Energy Resources of, or in any property acquired or proposed to be acquired by Cue Energy Resources in connection with its promotion of the Offer, or the Offer itself; and
- no director has, or has had in the two years prior to lodgement of this Prospectus with ASIC, an interest in:
- the formation or promotion of Cue Energy Resources;
- any property acquired, or proposed to be acquired, by Cue Energy Resources in connection with its formation or promotion of the Offer; or

- the Offer; and
- no amounts have been paid or agreed to be paid and no value or other benefit has been given or agreed to be given to any director, proposed director (or any entity in which either may be a partner or director) either to induce him or her to become, or to qualify him or her as, a director or otherwise for services rendered by him, her or it in connection with the Offer or the promotion of Cue Energy Resources.

#### Contracts

Mr E.G. Albers, a director of the Company, has a substantial shareholding in and is a director of Exoil Limited which is a 50% joint venturer with Cue Energy Resources in respect to the Bass Basin permits, T37P and T38P, and the Carnarvon Basin Permit WA-359-P. In addition, Mr Albers is a director and substantial shareholder of Gascorp Australia Ltd which is a 50% joint venturer with the Company in the Carnarvon Basin permits WA-360-P and WA-361-P.

Mr. R. Tweedie and Mr. K. Hoolihan, directors of Cue, are executives of Todd Petroleum Mining Company Limited (Todd), a company that has a 16% interest in PEP 38413 in the Taranaki Basin, New Zealand. Cue, as a result of its purchase of Delta Oil Taranaki Pty Ltd's 5% interest in PEP 38413, assumed the obligation to pay to Todd a royalty of US\$0.20 (plus GST) per barrel of crude oil produced from PEP 38413.

#### Interests in Shares

The Directors' relevant interests in Ordinary Shares (as defined in the Corporations Act 2001) as at the date of this Prospectus were as follows:

DIRECTOR	DIRECT	INDIRECT	TOTAL
*R. Tweedie	1,679,673	43,210,766	44,890,439
E.G. Albers	6,309,283	36,686,156	42,995,439
*K. Hoolihan	1,191,144	43,210,766	44,401,910
L. Musca	982,820	11,039,225	12,022,045

\* The relevant interests for Mr. R. Tweedie and Mr. K. Hoolihan include 43,057,758 shares held by Todd.

The holders of Ordinary Shares in which Directors have relevant interests will be entitled to participate in the Offer and are entitled to their pro-rata allocation.

### **Remuneration**

The Constitution contains several provisions as to remuneration of Directors. As remuneration for services, each Director is to be paid an amount determined by the Board, subject to a maximum aggregate amount for non executive Directors of AUD\$210,000 per annum. Any Director who devotes special attention to the Company's business, or who otherwise performs services which in the opinion of the Board are outside the scope of the ordinary duties of a Director or who, at the request of the Board, engages in any journey on the business of the Company, may be paid a fee for the services as determined by the Board.

In addition, every Director is entitled to be paid all reasonable travel, accommodation and other expenses incurred by the Director in attending meetings of the Company, the Board or of any committees or while engaged in the business of the Company.

### **Underwriting Fees and Commission**

As previously disclosed, both Mr. R.G. Tweedie and Mr. K. Hoolihan are officers of Todd Petroleum Mining Company Limited, an underwriter, but will not directly participate in or benefit from payment of those underwriting fees to the extent received by that entity. Mr E.G. Albers is a shareholder and director of Great Missenden Holdings Pty Ltd, an underwriter, and will indirectly benefit from payment of those underwriting fees to the extent received by that entity.

### **Interests and Consents of Experts and Other Persons**

PKF has given and has not, at the date of this Prospectus, withdrawn its consent to being named in this Prospectus as auditor to Cue Energy Resources Limited in the form and context in

which it is so named and to the issue of the Prospectus with references to the Financial Report for the 6 months ended 31 December 2004 in the form and context in which those references are so included. Other than referred to above, PKF was not involved in the preparation of any part of the Prospectus and has not authorised or caused the issue of any part of this Prospectus.

Computershare Investor Services Pty Limited has given and has not, at the date of this Prospectus, withdrawn its written consent to being named in the Prospectus as the Share Registrar of the Company in the form and context in which it is named. Computershare Registrar Services Limited has not participated in the preparation of the Prospectus and has only authorised or caused the issue of those parts of the Prospectus which comprise references to it as the Share Registrar of the Company in the form and context in which those references are included.

Each of Todd Petroleum Mining Company Ltd and Great Missenden Holdings Pty Ltd has given and has not, at the date of this Prospectus, withdrawn its consent to being named in the Prospectus as the Underwriters of the New Shares offered by this Prospectus in the form and interest in which it is named. They have not participated in the preparation of the Prospectus and have only authorised or caused the issue of those parts of the Prospectus which comprise reference to them as the Underwriters in the form and context in which those references are included.

### **Consent to Lodgement**

Every Director has consented to the lodgement of this Prospectus with ASIC under the Corporations Act.

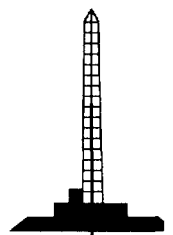
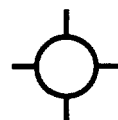

# CAPITAL STRUCTURE AND EFFECT OF THE ISSUE ON THE COMPANY

## 1. CAPITAL STRUCTURE

### 1.1 Existing Capital Structure

The existing capital structure comprises:

- (a) 435,443,755 ordinary shares;
- (b) 3,000,000 executive options, as set out in the table, immediately below.

Number	Exercise Price	Expiry Date
500,000	12 cents	02/05/06
500,000	15 cents	02/05/06
1,000,000	30 cents	02/05/06
1,000,000	35 cents	02/05/07

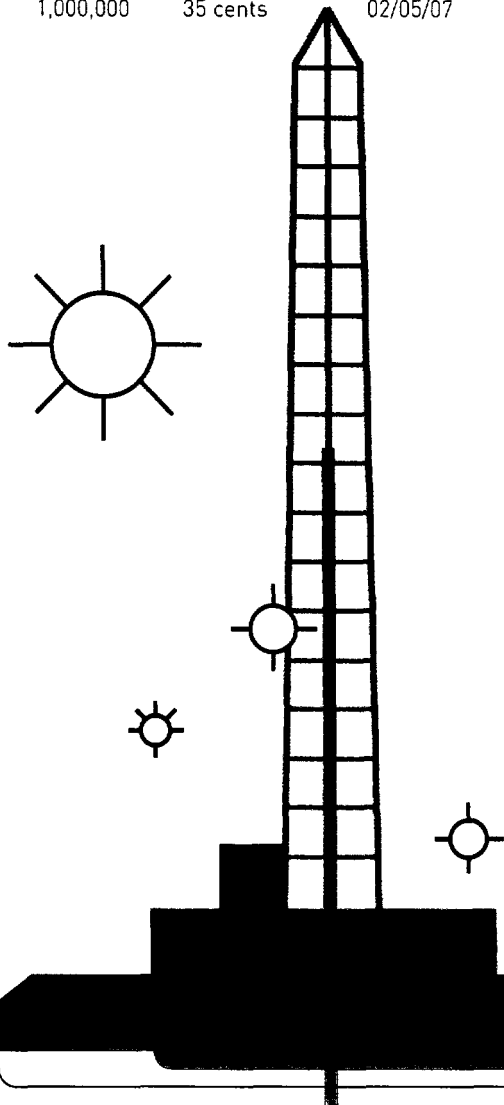

### 1.2 Capital Structure on Completion of the Public Issue

On the issue and allotment of all shares pursuant to this Prospectus, on the assumption that the Offer is fully subscribed, the ordinary share capital of the Company will have increased to 522,532,506 shares, of which 87,088,751 ordinary shares will be issued pursuant to this Prospectus.

## 2. EFFECT OF THE ISSUE ON THE COMPANY

The principal effects of the Issue on the Company will be that if the Issue is fully subscribed then:

- 2.1 the Company will raise an amount of \$17,417,750 (less the costs of the Issue). In addition, the receipt of the subscription moneys will alter the net asset backing of each share on issue in the capital of the Company.
- 2.2 the capital of the Company will be increased by a total of 87,088,751 shares.

The effect of the Issue on the Statement of Financial Position of the Company is set out below. The Pro-forma Statement of Financial Position is based on the Company's half-year Financial report which was reviewed by the Company's auditor. The placement in February 2005 of 60 million shares at 30 cents less costs, has also been included in the proforma. The Pro-forma statement assumes that this Issue is fully subscribed, that the costs of the Issue have been paid and that the net proceeds of the Issue have been received as cash but does not reflect the application of funds as those additional expenditures will be made over time.

## PROFORMA CONSOLIDATED STATEMENT OF FINANCIAL POSITION AS AT 31 DECEMBER 2004

The table below sets out the proforma statement of financial position on the basis described in the preceding section.

	31/12/04 \$AUD'000	Adjustments for 60 Million Share Placement in February 2005 \$AUD'000	Adjustments for Implementation of Entitlement Offer \$AUD'000	Proforma Combined \$AUD'000
<b>CURRENT ASSETS</b>				
Cash assets	13,078	17,098	16,458	46,634
Receivables	1,123	-	-	1,123
<b>TOTAL CURRENT ASSETS</b>	<b>14,201</b>	<b>17,098</b>	<b>16,458</b>	<b>47,757</b>
<b>NON-CURRENT ASSETS</b>				
Cash Assets	70	-	-	70
Property, plant & equipment	21	-	-	21
Other financial assets	508	-	-	508
Exploration and evaluation expenditure	25,451	-	-	25,451
Production properties	4,896	-	-	4,896
<b>TOTAL NON-CURRENT ASSETS</b>	<b>30,946</b>	<b>-</b>	<b>-</b>	<b>30,946</b>
<b>TOTAL ASSETS</b>	<b>45,147</b>	<b>17,098</b>	<b>16,458</b>	<b>78,703</b>
<b>CURRENT LIABILITIES</b>				
Payables	984	-	-	984
Redetermination deferred income	264	-	-	264
Provisions	61	-	-	61
	1,309	-	-	1,309
<b>NON-CURRENT LIABILITIES</b>				
Provisions	88	-	-	88
<b>TOTAL NON-CURRENT LIABILITIES</b>	<b>88</b>	<b>-</b>	<b>-</b>	<b>88</b>
<b>TOTAL LIABILITIES</b>	<b>1,397</b>	<b>-</b>	<b>-</b>	<b>1,397</b>
<b>NET ASSETS</b>	<b>43,750</b>	<b>17,098</b>	<b>16,458</b>	<b>77,306</b>
<b>EQUITY</b>				
Contributed equity	85,680	17,098	16,458	119,236
Reserves	236	-	-	236
Accumulated losses	(42,166)	-	-	(42,166)
<b>TOTAL EQUITY</b>	<b>43,750</b>	<b>17,098</b>	<b>16,458</b>	<b>77,306</b>

### Notes

**60 million share placement.** This adjustment has been calculated on the basis of proceeds received of AUD\$18M less costs of the offer of AUD\$0.902M.

**Implementation of the Entitlement Offer.** The adjustment has been calculated assuming the successful implementation of the Entitlement Offer resulting in proceeds of AUD\$17.418M, offset by AUD\$0.96M estimated costs of the Entitlement Offer.

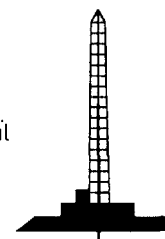

## GLOSSARY

The following definitions are used in this Prospectus, and unless the context otherwise requires they have the following meanings:

- **"AUD"** means Australian dollars.
- **"ASIC"** means the Australian Securities and Investment Commission.
- **"ASX"** means the Australian Stock Exchange.
- **"Chess"** means clearing house electronic sub-register system.
- **"Closing Date"** means 27 June 2005.
- **"Constitution"** means Cue Energy Resources' constitution.
- **"Cue Energy Resources"** or **"Cue"** or **"the Company"** means Cue Energy Resources Limited.
- **"Cue Energy Resources Group"** means Cue Energy Resources and its Subsidiaries.
- **"Directors"** means the directors of Cue Energy Resources Limited.
- **"Eligible Shareholders"** means a holder of Ordinary Shares registered at 5.00pm on the Record Date with a registered address in Australia, New Zealand, Papua New Guinea or Singapore.
- **"Entitlement and Acceptance Form"** means the entitlement and acceptance form accompanying this Prospectus.
- **"Existing Shares"** means the existing Ordinary Shares of the class on issue at the Record Date.
- **"Gas Sale Agreement"** means the agreement entered into between Santos (Sampang) Pty Ltd, Singapore Petroleum Sampang Ltd and Cue Sampang Pty Ltd as sellers, and PT Indonesia Power, as buyer, dated 19 July 2003.
- **"Joint Venture"** means the Sampang PSC joint venture entered into between the Joint Venture Parties.
- **"Joint Venture Parties"** means Santos (Sampang) Pty Limited, Singapore Petroleum Sampang Ltd and Cue Sampang Pty Limited.
- **"New Shares"** means the Ordinary Shares offered pursuant to this Prospectus.
- **"Offer"** means Cue Energy Resources Limited's offer of Rights and New Shares as contained in this Prospectus.
- **"Ordinary Shares"** means ordinary shares in the capital of Cue Energy Resources.
- **"POMSOX"** means the Port Moresby Stock Exchange.
- **"Record Date"** means 30 May 2005.
- **"Registrar"** means Computershare Investor Services Pty Limited in Victoria, Australia.
- **"Rights"** means the entitlement to subscribe for New Shares under the Offer.
- **"Sampang PSC"** means the Sampang production sharing contract entered into by Santos (Sampang) Pty Ltd, Cue Sampang Pty Ltd and Singapore Petroleum Sampang Ltd.
- **"scf/d"** means standard cubic feet per day.
- **"Security Renunciation Form"** means the security renunciation form accompanying this Prospectus.
- **"Shareholders"** means the holders of Ordinary Shares.
- **"Subsidiaries"** means, as at the date of this Prospectus, Galveston Mining Corporation Pty Ltd, Cue PNG Oil Pty Ltd, Cue Exploration Pty Ltd, Cue Energy Holdings Ltd, Cue Energy Indonesia Pty Ltd, Tanjung Jabung Pty Ltd, Cue Sampang Pty Ltd, Highlands Oil and Gas Pty Ltd, Toro Oil Pty Ltd and Omati Oil Pty Ltd.

All references to statutes or regulations are to statutes or regulations of Australia, unless otherwise specified in this Prospectus. All references to the time of the day are to Australian Eastern Standard time.

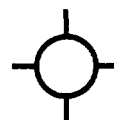

## APPENDIX A

### Continuous Disclosure Notices to ASX

10/05/2005	To make Renounceable Pro-rata Entitlement Offer	31/01/2005	Suspension from Official Quotation
06/05/2005	Delisting from NZ Stock Exchange	28/01/2005	Investor Presentation - January 2005
03/05/2005	Change of Director's Interest Notice x4	27/01/2005	Trading Halt
03/05/2005	Oyong Platform Installation Begins	24/01/2005	Corr: Second Quarter Activities & Cash Flow Reports
02/05/2005	Disclosure of Directors and Officers Relevant Interests	24/01/2005	First Quarter Activities & Cashflow Reports
02/05/2005	Appendix 3B - Exercise & Issue of Options	21/01/2005	Jeruk -2 Well Results
29/04/2005	SE Gobe 11 Extends Field	20/01/2005	Buys 5% Interest in Maari Oil Field NZ
29/04/2005	Reinstates in Jeruk Oil Discovery	17/01/2005	PNG Seismic Survey Begins
27/04/2005	Third Quarter Activities & Cashflow Reports	12/01/2005	Change in substantial holding
14/04/2005	Oyong Oil & Gas Field Development Approval	12/01/2005	Appendix 3B
11/04/2005	Jeruk 3D Seismic Survey Begins	22/12/2004	Placement Finalized
18/03/2005	Maari Oil Field Purchase Finalised	15/12/2004	Placement & Progress Report
07/03/2005	SE Gobe - 11 Begins Drilling	15/12/2004	Appendix 3B
28/02/2005	Half Yearly Report & Half Year Accounts	15/12/2004	Trading Halt
14/02/2005	Proposed Petrochemical Plant - Port Moresby New Guinea	07/12/2004	Accepts New Australian Exploration Permits
11/02/2005	Becoming a substantial holder	29/11/2004	Offered New Australian Exploration Permits
10/02/2005	Now Incorporated in Australia	26/11/2004	Results of Meeting & Chairman's Address
10/02/2005	Recent Placements - Corporations Act Disclosure	19/11/2004	Amended Disclosure of Director's Relevant Interests
09/02/2005	Appendix 3B - Acq/Project Devts/ Working Capital	18/11/2004	Appendix 3B - In satisfaction of options exercised
08/02/2005	Change of Director's Interest Notice x4	18/11/2004	Disclosure of Directors & Officers Relevant Interest
08/02/2005	Cue Awarded New Australian Exploration Permits	12/11/2004	Issue of Securities Unlisted Options
04/02/2005	Sale & Purchase Agreement for Maari Field Purchase	08/11/2004	Grant of Unlisted Options
01/02/2005	Placement of 60m shares to raise \$18m	04/11/2004	Disclosure of subsequent director relevant interest
01/02/2005	Reinstatement to Official Quotation	01/11/2004	Notice of Annual General Meeting
31/01/2005	Share Placement	25/10/2004	Jeruk Oil Discovery
		19/10/2004	First Quarter Activities & Cash Flow Reports
		29/09/2004	Early Oil Development Planned for Oyong

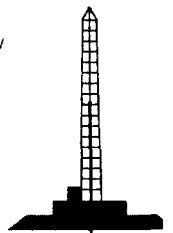

This page has been left blank intentionally

